



# PROFESSIONAL SPRAYERS USER'S MANUAL

## Safety Precautions

- Do not pressurize tank with external air or gas source; do not pressurize above 50 psi.
- Do not adjust the tip or change spray patterns while depressing the valve trigger.
- Open tank cap slowly to release air before removing; keep tank upright when releasing pressure.
- Do not store or transport the unit while tank is pressurized.

## Before Starting

- Inspect the hose, tank gasket, discharge valves, and nozzle for signs of wear or damage. These parts must be in full working condition to permit tank pressurization.
- It is recommended that compressed-air sprayers be used with a pressure gauge (B&G #AG-3) or a pressure regulator (B&G #460) fitted to the valve.

## Operating Instructions

### Filling and Mixing

- When mixing insecticides in the tank, first add about 1/2 the water then the chemical, followed by the remainder of the water required.
- Note gallon marks on the side of the tank and mix accordingly.
- Replace the pump and tank cap assembly, be sure the tank gasket fits properly; tighten the cap until snug (do not over tighten).
- Mix all insecticides according to label directions.

### Pressurizing the Tank

- Disengage the handle from locked position by pressing down and turning 1/4 turn to the left.
- Pump plunger up and down until desired pressure for application is achieved, then engage handle in the locked position.

## Operation

B&G sprayers are designed for a variety of professional uses, such as outdoor perimeter spraying, and indoor spraying, which includes surface treatments and crack-and-crevice applications.

## Application Rates\*

50° coarse fan = 14.1 oz/min

80° fine fan = 6.4 oz/min

Pin stream = 8.9 oz/min (large)  
4.5 oz/min (small)

\*Calibrated at 20 psi

## Care and Maintenance

- Flush tank, valve, and extension with clean water regularly.
- Do not use bleach or ammonia-based cleaners, these will damage the stainless steel and brass parts.
- After rinsing the tank with clean water, pressurize the tank and flush the valve and hose.
- Inspect hoses and hose connections, gaskets, washers and other fittings for wear; replace when necessary.
- Clean the filter at the hose/valve connection regularly.
- Do not use metal objects to clean the orifices in the nozzle, this will disrupt the liquid spray pattern.
- Use the B&G Cleaning Kit (#22028000) for regular maintenance and cleaning of the sprayer.

## Trouble Shooting

**Problem:** Tank not holding pressure

- Solution:**
- Tighten tank cap
  - Replace tank gasket (P-268)

**Problem:** Tank not getting air pressure

- Solution:**
- Replace plunger cup (NPO-277)
  - Replace or add oil to leather plunger cup

**Problem:** Pump cylinder filling with water when pumping

- Solution:**
- Clean around the check valve at the bottom of pump cylinder
  - Replace the check valve (PV-266)

**Problem:** Holds pressure, but will not spray

- Solution:**
- Nozzle clogged, clean with a soft brush
  - Cracked siphon tube, replace
  - Siphon tube clogged, clean end
  - Clean strainer at the base of the valve, at the hose / valve junction

**Problem:** Hose leaks at tank fitting

- Solution:** Replace hose washer (D-51-P)

**Problem:** Valve body leaking

- Solution:**
- *Extenda-Ban:* Tighten packing nut, replace packing washers (in D-124 Repair Kit)
  - *XR-Valve:* Replace O-ring at base of handle; replace copper gasket at base of valve stem (in GT-100 Repair Kit)
  - *Ban-Drip:* Tighten packing nut; replace rod packing (RP-48)

**Problem:** Tip Leaking

- Solution:**
- *Extenda-Ban:* Clean or replace soft seat gasket, replace valve spring (in GD-124 Repair Kit)
  - *XR-Valve:* Clean or replace check valve at end of valve extension
  - *Ban-Drip:* Clean or replace seat gasket; replace rod spring (RS-49)

# SPRAYER VALVES

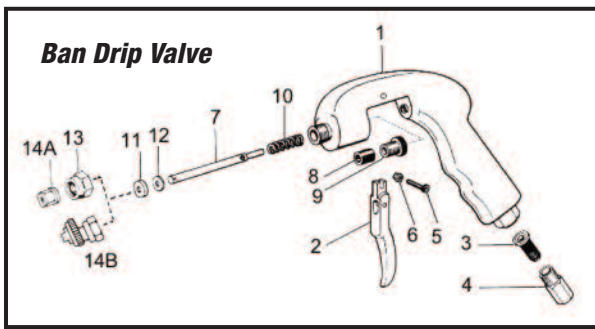

## BAN-DRIP VALVE

#	Part #	Description	#	Part #	Description
1	VB-40	Valve body	9	RP-48	Rod packing
2	VT-41	Valve trigger	10	RS-49	Rod spring
3	SA-42	Mesh strainer	11	SGH-50	Seat gasket holder
4	SB-43	Pipe strainer	12	TSG-51	Seat gasket
5	TS-44	Trigger screw	13	TC-52	Tip cap
6	TN-45	Trigger nut	14A	800067	Fine fan tip
7	VR-46	Valve rod, pin	14B	5850	Multitejet assembly
8	PN-47	Brass packing nut			

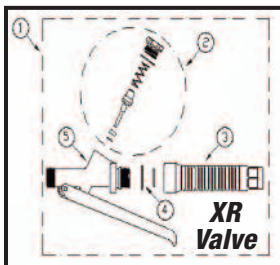

## XR VALVE

#	Part #	Description
1	22037500	Valve assembly
2	22037510	XR Valve Kit
3	22037503	Handle
4	22037508	O-ring (Viton)
5	22037501	XR Valve body

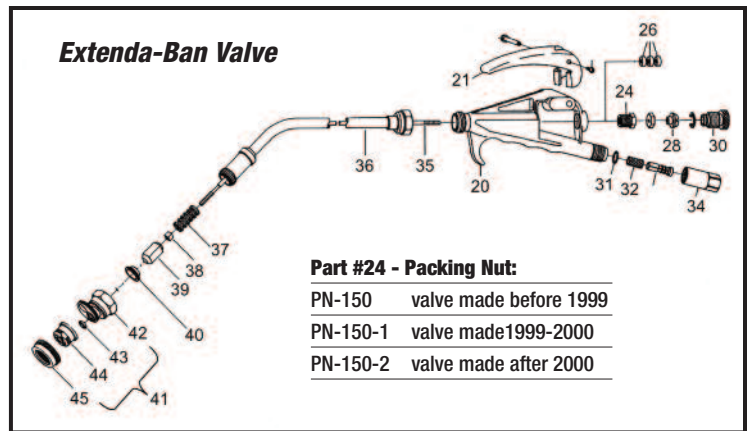

### Part #24 - Packing Nut:

PN-150	valve made before 1999
PN-150-1	valve made 1999-2000
PN-150-2	valve made after 2000

## EXTENDA-BAN VALVE

#	Part #	Description	#	Part #	Description
20	VB-147	Valve body	36	VE-164	Valve extension, 24 in.*
21	VT-140	Valve Trigger Kit		VE-154-SS	Valve extension, 8 in.**
24	PN-150-2	Packing nut (s. steel)		VE-155-SS	Valve extension, 18 in.**
26	VP-151	Valve packing washer		VE-164-SS	Valve extension, 24 in.**
28	AS-148	Adjustment Screw Kit	37	VS-156	Valve spring
30	SL-162	Safety lock nut	38	SSL-157	Seat stem nut
31	NG-146	Nylon gasket	39	SS-158	Seat stem
32	MS-145-50	Mesh Strainer Kit	40	SP-159	Soft seat gasket
34	SA-143	Strainer housing	41	5850-CC	Multitejet tip assembly
35	VC-152	Valve cable, 9 in.	42	9751-M	Multitejet tip holder
	VC-153	Valve cable, 18 in.	43	4190	Viton gasket
	VC-163	Valve cable, 24 in.	44	5800-CC	Multitejet CC tip
36	VE-154	Valve extension, 8 in.*	45	4596	Tip retainer
	VE-155	Valve extension, 18 in.*			

\* = brass \*\* = stainless steel

B&G Help Line  
**800-544-8811**



135 REGION SOUTH DRIVE • JACKSON, GA 30233  
Toll Free 800-544-8811 • Phone 678-688-5601  
www.bgequip.com • Fax 678-688-5633

## TANK AND HOSE

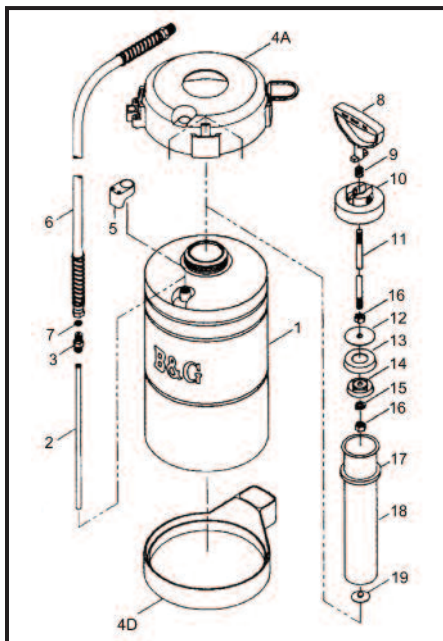

## STAINLESS STEEL SPRAYER

#	Part #	Description	#	Part #	Description
1	T-50	Tank, 1/2 gal., 2 L	9	P-276	Pump lock spring
	T-100	Tank, 1 gal., 4 L	10	P-274	Pump cap
	T-200	Tank, 2 gal., 7.6 L	11	PH-273	Plunger rod, 1/2 gal.
	T-300	Tank, 3 gal., 11.3 L		PO-273	Plunger rod, 1 gal.
	T-500	Tank, 5 L		PF-265	Plunger rod, 2 gal., 5 L
2	HS-297	Siphon tube, 1/2 gal., 2 L		PT-265	Plunger rod, 3 gal.
	OS-297	Siphon tube, 1 gal., 4 L	12	P-272	Back plate
	TS-297	Siphon tube, 2 gal., 7.6 L	13	NP-277	Polypropylene cup
	THS-297-01	Siphon tube, 3 gal., 11.3 L	14	NP-270	Cup spreader plate
	FS-297	Siphon tube, 5 liter	15	P-269A	Lock washer
3	HA-298	Adapter, hose	16	P-269-SS	Plunger nut
4A	TT-1	Tank top (1 gal.)	17	P-268	Pump gasket
4D	TB-1	Tank bottom	18	PH-267	Pump tube, 1/2 gal., 2 L
5	5700-H	Tip holder		PO-267	Pump tube, 1 gal., 4 L
6	D-50	Hose, 4 ft. red		PF-267	Pump tube, 2 gal., 7.6 L
7	D-51-P	Hose washer		PT-267	Pump tube, 3 gal., 11.3 L
8	P-275	Pump handle	19	PV-266	Check valve

## EXTENDA-BAN VALVE REPAIR AND MAINTENANCE

**1** Detach the Valve and Extension from the hose. Carefully remove the mesh strainer. Squeeze the Trigger to drain all liquid from the Valve.

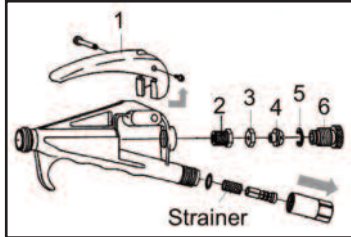

**2** Remove the Trigger (1), then the Snap ring (5), Safety lock nut (6), the Adjustment screw (4), the Lock nut (3), and then the Packing nut (2). The Trigger can be removed by moving it to the back of the Valve.

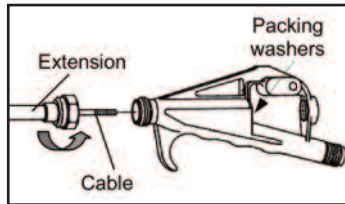

**3** Unscrew the extension at the front of the valve. The extension can be pulled away from the valve along with the interior steel cable.

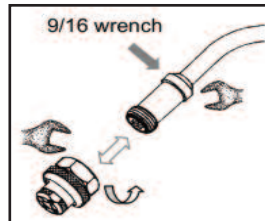

**4** Packing washers (white) that were at the end of the cable will remain inside the valve. Carefully dislodge and remove these washers.

**5** Remove the tip and nozzle assembly from the end of the extension, be careful to keep the Soft seat gasket. **Use 2 wrenches to loosen the tip:** one to hold the extension, and a second to loosen the tip. **Note: the extension may become twisted and unusable unless 2 wrenches are used to remove the tip.** Inspect the soft seat gasket and the small O-ring on Multeejet tips, replace if damaged or worn. Replace the nozzle if it is more than 2 years old.

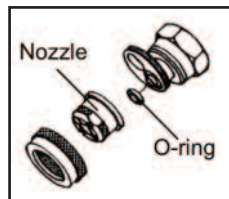
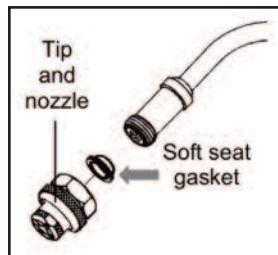

**6** Push the cable out the front of the Extension to expose the Spring, the small Lock nut, and the Seat stem. Unscrew the Seat stem and Lock nut, and slide off the Spring. Place these small pieces in a closed container (they are easily misplaced).

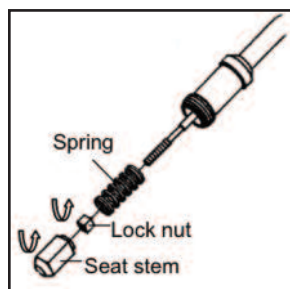

**7** Remove the stainless steel cable by pulling it slowly through the **back end of the Extension** – you cannot pull the cable through the front of the Extension. The threaded end of the cable at the nozzle end is short and easily passes through the curve in the Extension. The end of the cable at the valve end is long and will not pass through the curve. Replace the cable if it is worn or damaged.

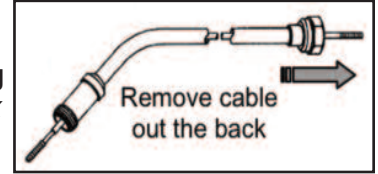

**8** Re-assemble the Extension by inserting the short end of the cable into the back so that threads are exposed at the nozzle end.

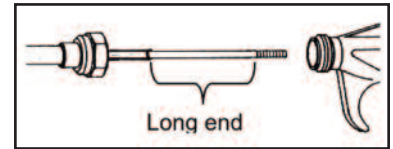

**9** Slide the Spring onto the end of the cable, then the Seat stem lock nut. Screw lock nut to leave **about 4 threads** at the base of the end of the cable.

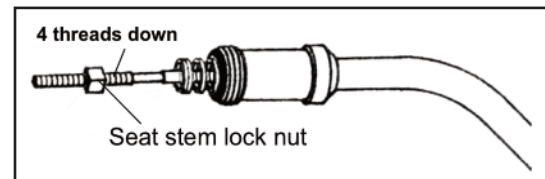

**10** Attach the Seat stem onto the cable, in front of the Lock nut. Hand tighten Seat stem against the lock nut.

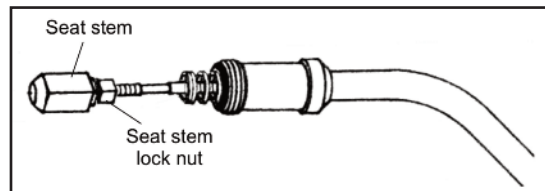

**11** Insert the long end of the cable into the front end of the valve. Push the cable through the valve until the end is through the back of the valve. Tighten Extension to the valve body.

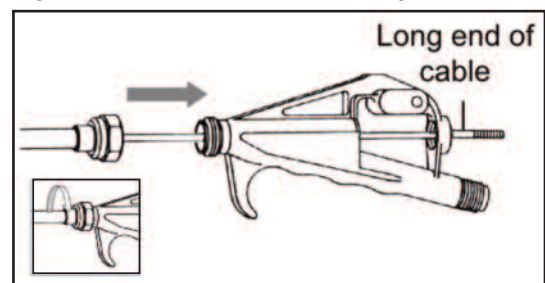

12

Insert 2 or 3 Packing washers onto the cable, then slide on the Packing nut behind the washers and tighten.

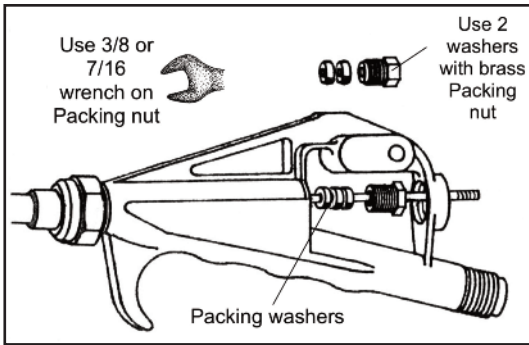

- Valves built **before 1999** have a stainless steel Packing nut that takes 3/8 wrench, there is no internal O-ring, these valves need 3 washers.
- Valves built **between 1999 and 2000** have a brass Packing nut + O-ring, this nut takes a 7/16 wrench, these valves need 2 washers.
- Valves built **after 2000** have a stainless steel Packing nut + O-ring, this nut takes a 3/8 wrench, and these valves require 3 washers.

13

Screw onto the cable the Lock nut and the Adjustment screw. Turn the Adjustment screw so the end of the cable is level to the top of the slot in the top of the screw. Tighten the Lock nut against the screw.

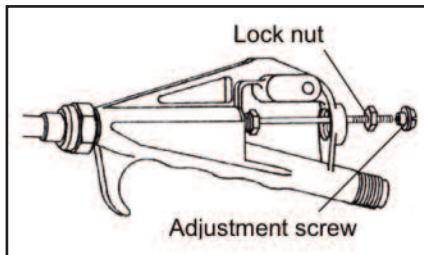

14

Attach the valve trigger by inserting it into the space between the Lock nut and Adjustment screw, then insert the Trigger screw.

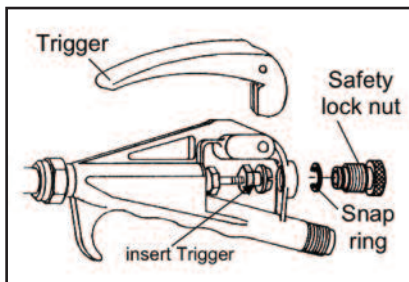

15

Screw the Safety lock nut into the valve body, and then attach the Snap ring.

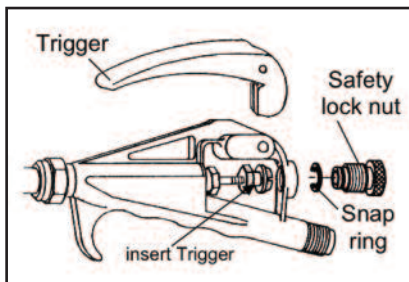

16

Attach the tip and nozzle to the end of the Extension, make certain the Soft seat gasket is facing correctly. The small end faces the Extension. Press the Trigger to retract the Seat stem into the Extension, then attach the tip and nozzle.

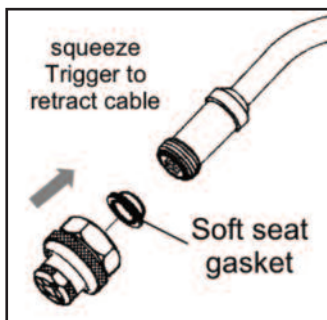

# STAINLESS STEEL SPRAYER

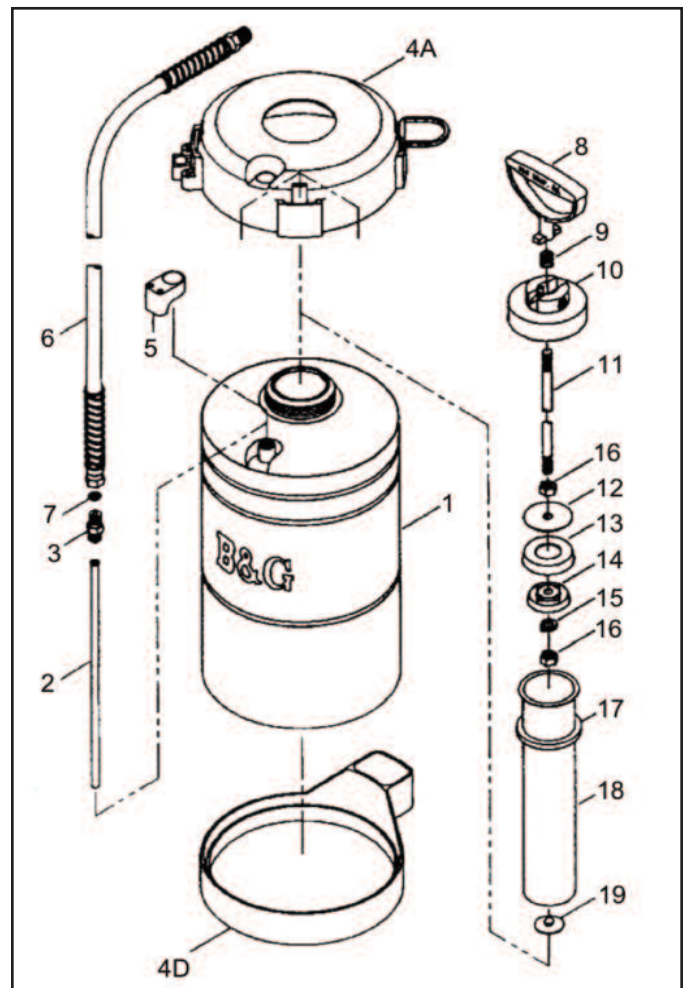

#	PART #	ORDER #	DESCRIPTION
1	T-50	22024800	Tank - 1/2 Gallon
	T-100	22025000	Tank - 1 Gallon
	T-200	22025100	Tank - 2 Gallon
	T-300	22025200	Tank - 3 Gallon
	T-500	22025250	Tank - 5 Liter
2	HS-297	22025600	Siphon tube - 1/2 Gallon
	OS-297	22025700	Siphon tube - 1 Gallon
	TS-297	22025800	Siphon tube - 2 Gallon
	THS-297-01	22025901	Siphon tube - 3 Gallon
	FS-297	22025950	Siphon tube - 5 Liter
3	HA-298	22025300	Adapter - hose
4A	TT-1	22049476	Tank top (1 Gallon)
4D	TB-1	22049477	Tank bottom
5	5700-H	22049475	Tip holder
6	D-50	22030100	Hose - 4 ft. red
7	D-51-P	22030400	Hose washer
8	P-275	22029800	Pump handle
9	P-276	22029900	Pump lock spring
10	P-274	22029700	Pump cap
11	PH-273	22029400	Plunger rod - 1/2 Gallon
	PO-273	22029500	Plunger rod - 1 Gallon
	PF-273	22029650	Plunger rod - 2 Gallon - 5 Liter
	PT-273	22029600	Plunger rod - 3 Gallon
12	P-272	22029200	Back plate
13	NP-277	22029000	Polypropylene cup
14	NP-270	22028600	Cup spreader plate
15	P-269A	22028400	Lock washer
16	P-269-SS	22028250	Plunger nut
17	P-268	22028000	Pump gasket
18	PH-267	22027400	Pump tube - 1/2 Gallon
	PO-267	22027500	Pump tube - 1 Gallon
	PF-267	22027650	Pump tube - 2 Gallon
	PT-267	22027600	Pump tube - 3 Gallon
19	PV-266	22027200	Check valve

# TANK SPRAYER PROBLEMS AND SOLUTIONS

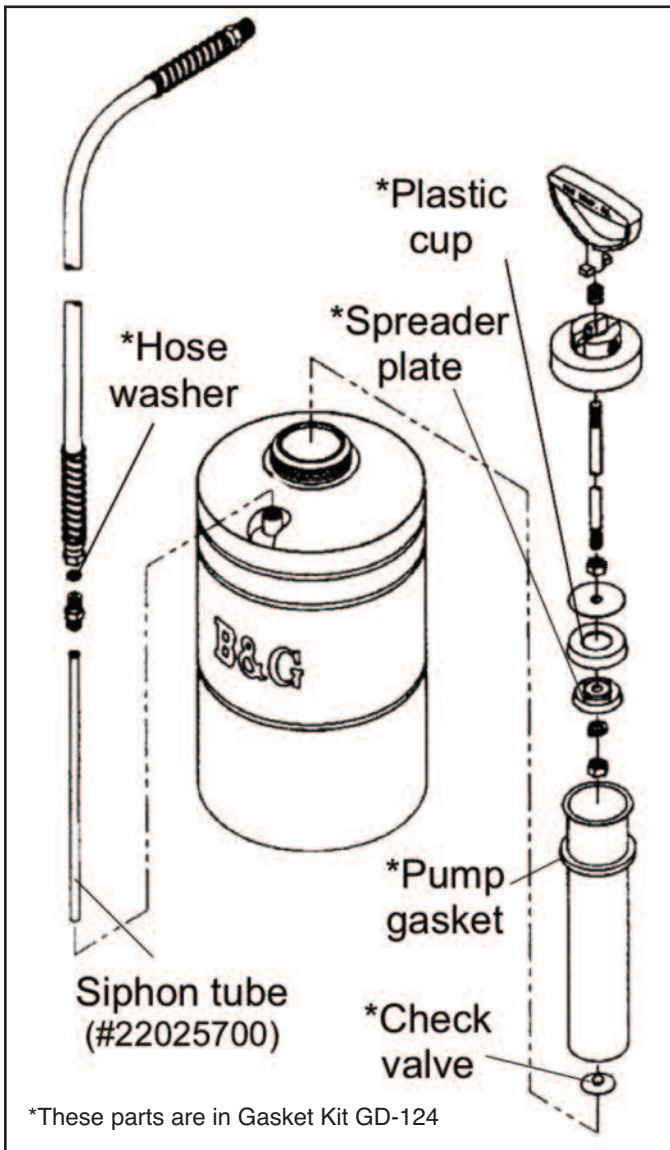

**Problem:** Tank is not holding pressure; pump is working but no pressure remains in the tank.

**Solution:** Check Pump gasket, replace if cracked.

**Problem:** Tank is not getting pressure; the pump seems to be working but no pressure builds in the tank.

**Solution:** Grease Plastic cup in pump tube, or replace cup and Spreader Plate.

**Problem:** Pump cylinder fills with liquid, pumping is difficult.

**Solution:** Clean dirt from bottom of pump tube, replace Check valve at bottom.

**Problem:** Won't spray; tank holds pressure but there is no spray from the nozzle, **a new sprayer**.

**Solution:** Replace Hose washer, it may have been damaged when hose was attached to tank; the junction may have been over-tightened!

**Problem:** Tank holds pressure, but there is no spray from nozzle (**old sprayer**).

**Solution:**

(1) Siphon tube is clogged or cracked, it must be cleaned or replaced.

(2) Clean the mesh Strainer at the end of the hose near the valve.

(3) Clean the nozzle with a small brush.\*

(4) Clean or replace Soft seat gasket at the end of the extension.

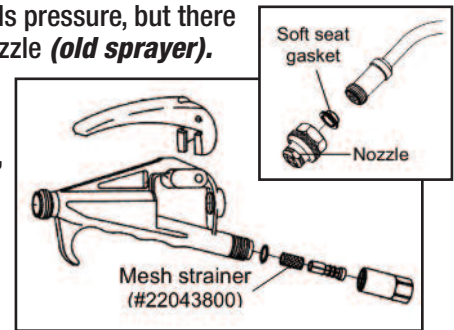

**Problem:** Valve is leaking around the Packing nut, and the handle is wet.

**Solution:**

(1) Tighten the Packing nut.

(2) Replace the valve Packing washers.

**2 washers** with brass Packing nut

**3 washers** with stainless steel Packing nut

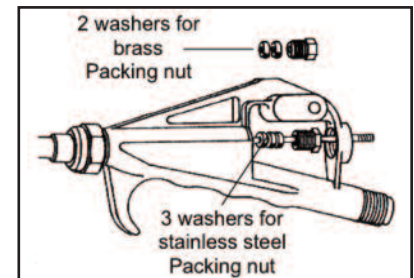
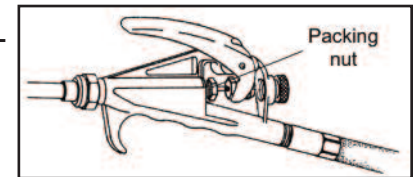

**Problem:** Extension is leaking at the tip, a constant drip from the tip.

**Solution:**

(1) Clean or replace nozzle O-ring.

(2) Clean end of Seat stem.

(3) Clean or replace Soft seat gasket.

(4) Replace the Valve spring.

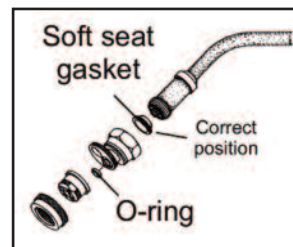
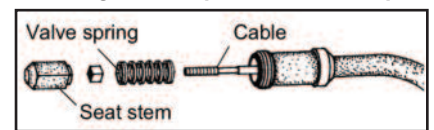

**Problem:** Hose is leaking at the connection with the tank; leaks when tank is pressurized.

**Solution:** Replace the Hose washer at the end of the hose; do not over-tighten the connection when reconnecting the hose to the tank.

