

Art.Nr. 12058001-SB

Dichtungssatz Sprühleitung | Gasket set spraying equipment | Jeu de joints pour lance | Set di guarnizioni per impugnatura

# Flox 10, Iris 15, Senior 20, Spray-Matic 10 B, REC 15 AC1, AC2, PC1, PZ1

Für Flox 10, Iris 15 (AT1, AT2, AT3, PT1), Spray-Matic 10 B und REC 15 (AC1, AC2, PC1, PZ1) ab 2019  
 For Flox 10, Iris 15 (AT1, AT2, AT3, PT1), Spray-Matic 10 B and REC 15 (AC1, AC2, PC1, PZ1) from 2019  
 Pour Flox 10, Iris 15 (AT1, AT2, AT3, PT1), Spray-Matic 10 B et REC 15 (AC1, AC2, PC1, PZ1) à partir de 2019  
 Per Flox 10, Iris 15 (AT1, AT2, AT3, PT1), Spray-Matic 10 B e REC 15 (AC1, AC2, PC1, PZ1) dal 2019



29	Flachdichtung   Gasket   Joint   Guarnizione	24 x 16.2 x 2
30	Flachdichtung   Gasket   Joint   Guarnizione	24 x 16.2 x 2
22	Flachdichtung   Gasket   Joint   Guarnizione	17 x 11 x 1.5 (2 x)
33	Flachdichtung   Gasket   Joint   Guarnizione	17 x 12.7 x 2
34	Flachdichtung   Gasket   Joint   Guarnizione	12.2 x 7 x 3
35	O-Ring   O-ring   Joint torique   O-ring	7.66 x 1.78
32	Stopfbüchspackungsring   Gland packing Garniture presse-étoupe   Baderna	14.7 x 5.1 x 10.5
31	Ventilstange   Valve rod   Tige de soupape Asta della valvola	
31	Formdichtung   Shaped packing Joint d'étanchéité en form   Guarnizione	11.8 x 4 x 4
31	Fassung   Rim   Support   Montaggi	
28	Filter   Filter   Filtre   Filtro	

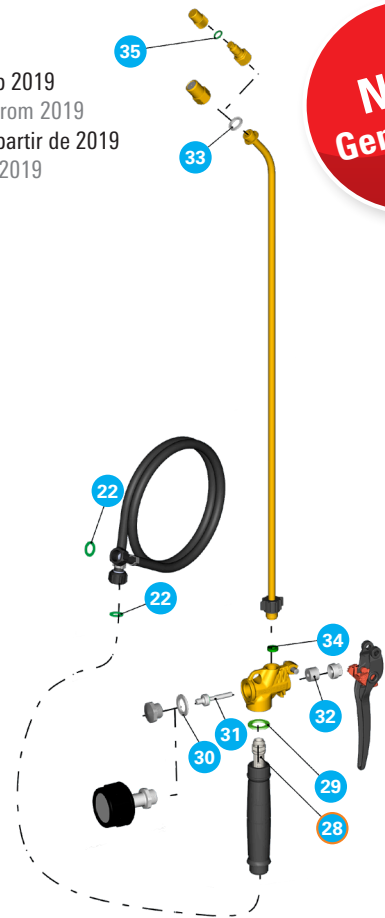

Für Flox 10, Iris 15, Senior 20, Spray-Matic 10 B und REC 15 PZ1 bis 2018  
 For Flox 10, Iris 15, Senior 20, Spray-Matic 10 B and REC 15 PZ1 to 2018  
 Pour Flox 10, Iris 15, Senior 20, Spray-Matic 10 B et REC 15 PZ1 à 2018  
 Per Flox 10, Iris 15, Senior 20, Spray-Matic 10 B e REC 15 PZ1 a 2018

30	Flachdichtung   Gasket   Joint   Guarnizione	24 x 16.2 x 2
29	Flachdichtung   Gasket   Joint   Guarnizione	24 x 16.2 x 2
22	Flachdichtung   Gasket   Joint   Guarnizione	17 x 11 x 1.5 (2 x)
33	Flachdichtung   Gasket   Joint   Guarnizione	17 x 12.7 x 2
34	Flachdichtung   Gasket   Joint   Guarnizione	12.2 x 7 x 3
32	Stopfbüchspackungsring   Gland packing Garniture presse-étoupe   Baderna	14.7 x 5.1 x 10.5
31	Ventilstange   Valve rod   Tige de soupape Asta della valvola	
28	Filter   Filter   Filtre   Filtro	

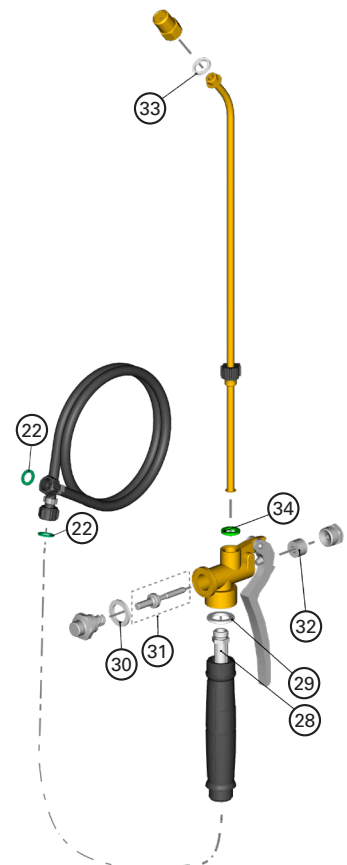

**i** Rückseite beachten  
 Note back  
 Veuillez lire le verso  
 Nota sul retro

Art.Nr. 12058001-SB

Dichtungssatz Sprühleitung | Gasket set spraying equipment | Jeu de joints pour lance | Set di guarnizioni per impugnatura

# Flox 10, Iris 15, Senior 20, Spray-Matic 10 B, REC 15 AC1, AC2, PC1, PZ1

Flachdichtung  
Gasket  
Joint  
Guarnizione

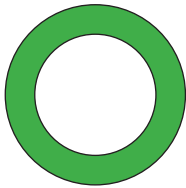

29 29 24 x 16.2 x 2

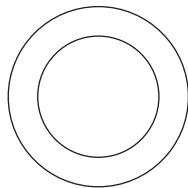

30 30 24 x 16.2 x 2

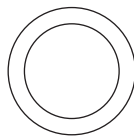

33 33 17 x 12.7 x 2

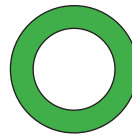

22 22 17 x 11 x 1.5  
(2 x)



34 34 12.2 x 7 x 3

O-Ring  
O-ring  
Joint torique  
O-ring



35 7.66 x 1.78

Stopfbüchspackungsring  
Gland packing  
Gorniture presse-étoupe  
Guarnizione pressacavo

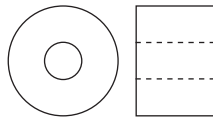

32 32 14.7 x 5.1 x 10.5

Fassung  
Rim  
Support  
Porta asta

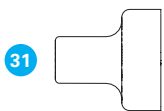

31

Formdichtung  
Shaped packing  
Joint d'étanchéité en form  
Guarnizione

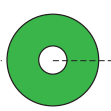

Ventilstange  
Valve rod  
Tige de soupape  
Asta della valvola

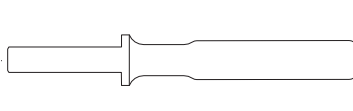

Ventilstange  
Valve rod  
Tige de soupape  
Asta della valvola

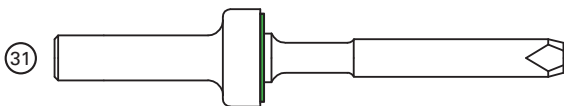

31

Filter  
Filter  
Filtre  
Filtro

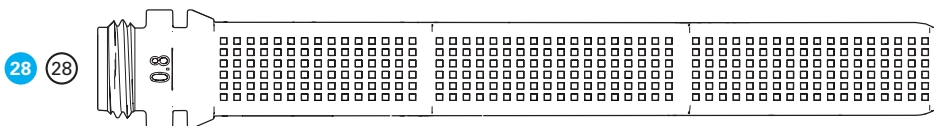

28 28

● Version ab 2019  
Version from 2019  
Version à partir de 2019  
Versione dal 2019

○ Version bis 2018  
Version to 2018  
Version à 2018  
Versione a 2018