



TERMITE TOOLS FOAM EQUIPMENT
FOGGERS GRANULARS LIQUIDS
RODENT PRODUCTS IPM PRODUCTS
BAITS LIGHT TRAPS



PROFESSIONAL CATALOG 2013

www.bgequip.com

WE ARE B&G

Quality Assurance



Quality Assurance and Precision Engineering are the basis of the B&G reputation in the Pest Control Industry. These qualities are the goals of the skilled manufacturing and assembly team at B&G Equipment Company.

Customer Service

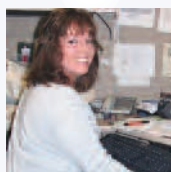

Customer Service and your satisfaction are important to the present and future of B&G. A dedicated team works to answer technical questions, complete orders, and coordinate shipping.

Technical Support

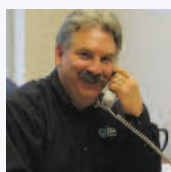

Get technical support from experienced former PMPs on staff at B&G. Averaging 15 years in the pest control industry, we are able to assist you in product recommendation, trouble shooting and repair of your equipment, along with most other pest related issues.

Engineering

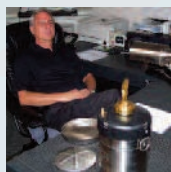

Innovation in product design is due to our highly talented Engineering Department. All of the B&G products are designed in-house to fit the exact need of the Pest Management Professional.



B&G Equipment Company's state-of-the-art manufacturing facility located in Jackson, Georgia.

Table of Contents

PRODUCT	PAGE
Tank Sprayer Selection Guide and Parts List	3-4
Tank Sprayer Parts Kits and Accessories	5-6
Termite Control Tools	7-8
AccuSpray Compact Sprayers	9
Aerosol and ULV Delivery	10-11
IPM Case	12
Fogging Equipment	13
Foaming Equipment	14-15
Specialty Sprayers	16
Dust Application	17-19
Rodent Control Products	21
Bait Gun and Carry Cases	22
Fly Control	23
Lo-Line Monitor	24
Monitors, Traps and Glue boards	25
B&G Training and Sales Material	26

What our customers are saying...

Richard Berman, BCE
TECHNICAL DIRECTOR
WALTHAM SERVICES, INC.

"B&G's ability and creativity developing new and better pieces of equipment continues to impress me. I'm glad they service and supply our industry."

Mike Masterson
CEO
ISOTECH PEST MANAGEMENT

"Using B&G products gives us the dependability and quality we count on so we can continue to provide our clients with the highest level of cutting-edge service."

Jennifer Leggett
PRESIDENT/OWNER
LINDSEY PEST SERVICES

"Thank you B&G for making us the best service providers in the industry. Your support of our industry and the quality equipment you provide, plus the education you offer, are second to none."

GREAT IDEAS FROM B&G

1

“Green Pest Control”

Looking to project a ‘green’ image? Instantly transform your business into a modern green look with these high performance IPM tools.



An effective monitoring program can reduce pesticide use and permits you to address problems where they occur. See page 24 for our complete line of monitoring products.



The revolutionary AccuSpray Professional sends an instant message to your customers that you are a high tech IPM company. See page 9 for additional information.

The all new “Green” B&G Sprayer lets your customers know that you are taking an environmentally friendly approach to pest control. See page 6 for more information.



The first true IPM Rodent Station: The B&G Fast Catch Station. See page 21 for more information.



3

Bedbug Treatment Equipment



The B&G Lo-Line has proven to be the most effective sticky trap monitor for bedbugs. See page 24 for more information.



The Ultimate Bedbug Tool: The B&G Portable Aerosol System. Cuts chemical usage and application time. See page 11 for more information.

2

“Increase Your Profits”

You can cut as much as 50% off your chemical cost by using these four money saving products.



Save on the cost of Aerosols. The B&G Portable Aerosol System (PAS) significantly increases speed of application which reduces your labor on bedbug, cockroach, and carpenter ant services. Go to page 11 to learn more.

Still using ‘free’ or generic bait guns? Many bait guns over apply bait by as much as 50%. Is your gun still ‘free’ when it applies twice the amount of bait recommended on the label? See page 22 for more information.



Genuine B&G Parts can help keep your equipment in perfect working order so that you can apply insecticides that meet the labeling requirements without worrying about over-application. Did you know that the average spray tip wears about 10% a year? Over several years this could cost you in wasted insecticide. See page 5 for more information.

Did you know that spray tips found on most commercially available backpacks over apply insecticide by up to 50%? The B&G PestPro Backpack is specially designed for the Pest Control Industry and meets the labeling requirements of most pesticides. Learn more on page 19.



Application of liquid insecticide is critical for any bedbug job. B&G has a complete line of liquid application equipment.

Application of dust is critical for an effective bedbug treatment. B&G offers many choices for dust application equipment. See pages 17-19.



TANK SPRAYERS

Tank Sprayer Selection Guide

The world famous B&G Sprayer is available in a variety of models and with features that fit every pest control application. Built from the highest quality components, the B&G Sprayer is designed for years of dependable service.



Extenda-Ban

Extenda-Ban Sprayers include the following features:

EXTENDA-BAN

Top quality valve for instant tip shut-off

4-WAY MULTEEJET TIP (except where noted)
With fine fan, coarse fan, pin stream, and either a Crack & Crevice Straw or orifice ("CC") or a second pin stream ("S")

The B&G 4-Way Tip meets the labeling requirements of most modern insecticides.

- 1/2 gallon = 2 Liter
- 1 gallon = 4 Liter
- 2 gallon = 7.6 Liter
- 3 gallon = 11.3 Liter

XR-Valve

XR-Valve Sprayers include the following features:

XR-GUN

The most cost effective gun still offering various extension lengths but without tip shut-off

4-WAY MULTEEJET TIP (except where noted)
With fine fan, coarse fan, pin stream, and either a Crack & Crevice Straw or orifice ("CC") or a second pin stream ("S")

Ban-Drip

TANK CAPACITY	EXTENSION	MODEL #	ORDER #
1/2 Gallon	9"	N74-CC	11003275
1 Gallon	9"	N124-CC	11003900
5 Liter	9"	N524-CC	11008400
1/2 Gallon	9" without C&C	N74-S	11003200
1 Gallon	9" without C&C	N124-S	11003500
5 Liter	9" without C&C	N524-S	11008450
1 Gallon	9" with fan tip only	N120-S	11003300
1/2 Gallon	18"	N74-CC-18	11003285
1 Gallon	18"	N124-CC-18	11003950
5 Liter	18"	N524-CC-18	11008425
2 Gallon	18"	N224-CC	11004300
3 Gallon	18"	N324-CC	11004600
1/2 Gallon	18" without C&C	N74-S-18	11003225
1 Gallon	18" without C&C	N124-S-18	11003700
2 Gallon	18" without C&C	N224-S	11004200
3 Gallon	18" without C&C	N324-S	11004500
2 Gallon	18" with fan tip only	N220-S	11004100
3 Gallon	18" with fan tip only	N320-S	11004400
1 Gallon	24"	N124-CC-24	11003924
5 Liter	24"	N524-CC-24	11008440
2 Gallon	24"	N224-CC-24	11004375
3 Gallon	24"	N324-CC-24	11004650
5 Liter	24" safety valve & gauge	N584-18-20	11009820

1/2 Gallon		N54-CC	11001195
1 Gallon	9"	N104-CC	11001450
1/2 Gallon	without C&C	N54-S	11001100
1 Gallon	9" without C&C	N104-S	11001400
1 Gallon	9" fan tip only	N100-S	11001200
1 Gallon	18"	N104-CC-18	11001460
2 Gallon	18"	N204-CC	11001705
1 Gallon	18" without C&C	N104-S-18	11001425
2 Gallon	18" without C&C	N204-S	11001700
1 Gallon	18" fan tip only	N100-S-18	11001203
2 Gallon	18" fan tip only	N200-S	11001600
3 Gallon	18" fan tip only	N300-S	11001800

1/2 Gallon	None	N64-CC	11002090
1 Gallon	None	N114-CC	11002600

SPRAYER PARTS LIST

See a video on how to service and maintain your B&G @ www.bgequip.com

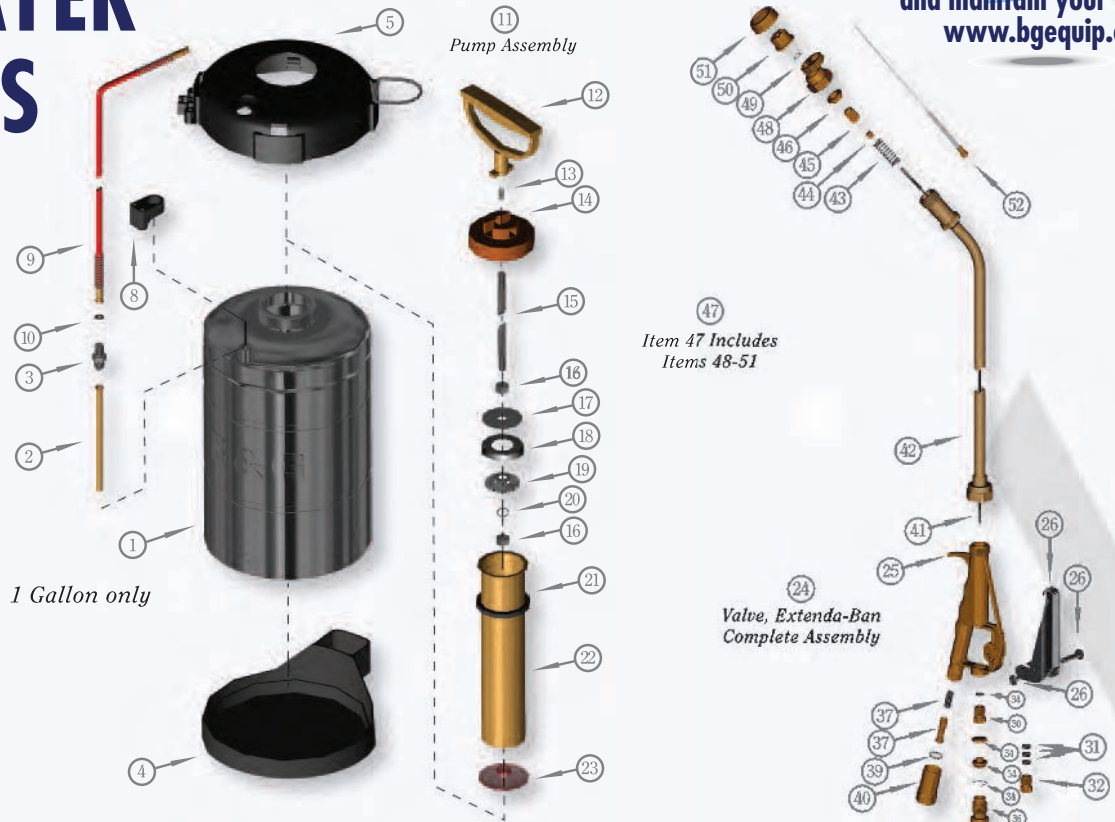

ITEM #	PART #	ORDER #	DESCRIPTION
1	T-50	22024800	Tank (1/2 Gallon)
	T-100	22025000	Tank (1 Gallon)
	T-200	22025100	Tank (2 Gallon)
	T-300	22025200	Tank (3 Gallon)
	T-500	22025250	Tank (5 Liter)
2	HS-297	22025600	Tube, Siphon (1/2 Gallon)
	OS-297	22025700	Tube, Siphon (1 Gallon)
	TS-297	22025800	Tube, Siphon (2 Gallon)
	THS-297-01	22025901	Tube, Siphon (3 Gallon)
	FS-297	22025950	Tube, Siphon (5 Liter)
3	HA-298	22025300	Adapter, Hose
4	TB-1	22049477	Bottom, Tank (1 Gallon Only)
5	TT-1	22049476	Top, Tank (1 Gallon Only)
8	5700-H	22049475	Holder, Tip (Not used with Item 5)
9	D-50	22030100	Hose, 4 ft., red
10	D-51-P	22030400	Washer, Hose
11	PH-265	22026900	Pump Assembly (1/2 Gallon)
	PO-265	22027000	Pump Assembly (1 Gallon)
	PF-265	22027125	Pump Assembly (2 Gallon & 5 Liter)
	PT-265	22027100	Pump Assembly (3 Gallon)
12	P-275	22029800	Handle, Pump
13	P-276	22029900	Spring, Pump Lock
14	P-274	22029700	Cap, Pump
15	PH-273	22029400	Rod, Plunger (1/2 Gallon)
	PO-273	22029500	Rod, Plunger (1 Gallon)
	PF-273	22029650	Rod, Plunger (2 Gallon & 5 Liter)
	PT-273	22029600	Rod, Plunger (3 Gallon)
16	P-269-SS	22028250	Nut, Plunger
	P-272	22029200	Plate, Back
18	NP-277	22029000	Cup, Polypropylene
	NP-271	22028800	Cup, Leather
19	NP-270	22028600	Plate, Cup Spreader
20	P-269A	22028400	Washer, Lock
21	P-268	22028000	Gasket, Pump
22	PH-267	22027400	Tube, Pump (1/2 Gallon)
	PO-267	22027500	Tube, Pump (1 Gallon)
	PF-267	22027650	Tube, Pump (2 Gallon & 5 Liter)

ITEM #	PART #	ORDER #	DESCRIPTION
22	PT-267	22027600	Tube, Pump (3 Gallon)
23	PV-266	22027200	Valve, Check
24	120	22042101	Valve, Extenda-Ban 9" (less tip)
	220	22042203	Valve, Extenda-Ban 18" (less tip)
	420	22042778	Valve, Extenda-Ban 24" (less tip)
25	VB-147	22044450	Valve Body Kit
26	VT-140	22042800	Trigger, Valve Housing, Screw
30	PN-150-2	22042455	Nut, Packing
30A	PN-150-1	22042454	(1999 - 2000) Nut, Packing
31	VP-151	22045099	Packing, Valve
32	PN-150	22044900	Nut, Packing (Prior to 1999)
34	AS-148	22044500	Adjusting Screw, Lock nut, Snap ring
36	SL-162	22046700	Nut, Safety Lock
37	MS-145-50	22043800	Strainer, 50 Mesh Support, Strainer
39	NG-146	22044200	Gasket, Nylon
40	SA-143	22043400	Housing, Strainer
41	VC-152	22045300	Cable, Valve 9"
	VC-153	22045400	Cable, Valve 18"
	VC-163	22045450	Cable, Valve 24"
42	VE-154	22045500	Extension, Brass 9"
	VE-155	22045600	Extension, Brass 18"
	VE-164	22045650	Extension, Brass 24"
	VE-154-SS	22045510	Extension, Stainless Steel 9"
VE-155-SS	22045610	Extension, Stainless Steel 18"	
VE-164-SS	22045710	Extension, Stainless Steel 24"	
43	VS-156	22045700	Spring, Seat Stem
44	SSL-157	22045900	Nut, Seat Stem
45	SS-158	22046100	Stem, Seat
46	SP-159	22046300	Gasket, Soft Seat
47	5850-CC	22049466	Multitejet C&C Tip Assembly (Parts 48-51)
	5850	22049451	Tip Assm (No C&C)
48	9751-M	22049300	Holder, Multitejet C&C Tip
49	4190	22034700	Gasket, Viton®
50	5800-CC	22049467	Tip, Multitejet C&C
	5800	22049452	Tip only (No C&C)
51	4596	22034500	Retainer, Tip
52	5700-B	22049200	Extension, Crack & Crevice

SPRAYER PARTS & ACCESSORIES

Tip Assemblies

DESCRIPTION	ORDER #	MODEL #
Multeejet C&C Tip Assembly (complete)	22049466	5850-CC
Multeejet Tip Assembly (complete)	22049451	5850
Pin-To-Cone (available with various flow rates)	22036600	5500-Y-2
Adjustable Pin-to-Cone	22083602	AV-210

Single Tips – A wide range available on request.

Nozzles

DESCRIPTION	ORDER #	MODEL #
Multeejet C&C Tip (4-way)	22049467	5800-CC
Multeejet Tip Only (no C&C orifice)	22049452	5800
Adjustable Tip Assembly	22035200	5900



Straws & Needles

DESCRIPTION	ORDER #	MODEL #
Plastic C&C Straw (fits directly on a gun with a 1325 Tip Cap)	22049500	100-CC
Ban-Drip Fan Tip (3/16" dia., 12" long) (requires 1325 Cap)	22039677	1052
1" plastic C&C Straw (fits in Multeejet C&C tip)	22071703	1603
6" plastic C&C Straw (fits in Multeejet C&C tip)	22049200	5700-B
3.5" Stainless Steel Injector Needle (fits in Multeejet C&C tip)	22049400	5700-SS
2" Stainless Steel Void Tip (fits in Multeejet C&C tip)	22071785	5700-2
4" Stainless Steel 4-way Void Tip (fits in Multeejet C&C tip)	22049425	5701
8" Mulch/Ant Mound Probe (fits any gun/ext. with 1325 Tip Cap)	22071684	100-8
1" Wood Injection Tip (requires 1325)	22071824	Whit-1
4" Wood Injection Tip (requires 1325)	22071827	Whit-4
1/2" Wood Injection Tip "better wood seal design" (requires 1325)	24040077	WoodTip

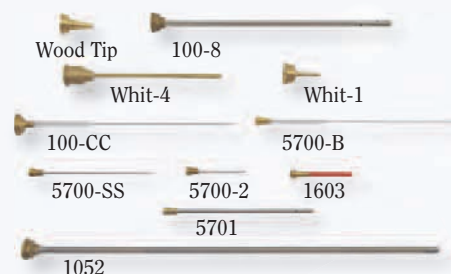

Gasket Kits

Designed for rebuilding sprayers. Includes the most commonly needed parts when repairing a sprayer.



DESCRIPTION	ORDER #	MODEL #
Sprayers with XR Valve	22049600	GT-100
Sprayers with Extenda-Ban Valve	22050100	GD-124

First Aid Kits

Same as the Gasket Kit but includes higher volumes of all parts. Good for conducting Care & Maintenance classes for an entire office.



DESCRIPTION	ORDER #	MODEL #
Sprayers with Extenda-Ban Valve	22050400	FA-600-D
Sprayers with Ban-Drip Valve	22050300	FA-600-B
Technician Emergency Kit	23088125	TE-125
Office Emergency Kit	23088126	OE-126

B&G Sprayer Tune-Up Kit **NEW**

Keeps your sprayer in perfect working order. Apply pesticides that meet labeling requirements without over-application. Includes instructional DVD on how to clean and repair your sprayer. Priced at a savings of over 20% compared to purchasing individual parts.

Kit includes GD-124 Repair Kit, DVD on maintaining and cleaning your sprayer, Cleaning kit, New 4-Way Tip, and Repair & Rebuild Manual



DESCRIPTION	MODEL #
Kit with 4-Way Crack & Crevice Tip	22049630
Kit with 4-Way Tip	22049631

Technician Emergency Kit

Commonly needed parts for most B&G equipment. Includes easy to understand drawings of parts, repair hints, and refill quantities. Works in conjunction with the Office Emergency Kit as a refilling station.



Office Emergency Kit

A great inventory system for B&G repair parts. Contains more quantities of those parts in the Technician Emergency Kit and also has many less common parts not included in the Technician Emergency Kit. Recommended for office supply rooms. Good for offices with 3-8 technicians. Includes easy to understand drawings of parts, repair hints, and refill quantities.



Green "B&G" Sprayer

Promotes a "Green Image" to your customers. Can be used with all natural products, most common insecticides and Non Repellant type products. In addition to promoting a green image, with its green top and bottom, it allows the technician to easily identify the contents of the sprayer.



- Models with 9" or 18" extensions available
- Chemical resistant hose
- 4-way tip
- Green top and carpet protector
- This sprayer meets the labeling requirements of most "Common Insecticides"

DESCRIPTION	ORDER #
Green Sprayer 9" Valve, CC Tip	11003917
Green Sprayer 18" Valve, CC Tip	11003958

NEW

Sprayer Caddy

Mounts in your service vehicle and holds your sprayer firmly in place. Helps prevent damage or chemical spillage during transportation.



- Heavy duty metal construction
- Chip resistant finish
- Mounting holes for either side or bottom mounting

DESCRIPTION	ORDER #
Caddy – 1 gallon & 5 liter (tall)	11009850
Caddy – 2, 3 gallon & 5 liter (short)	11009860

Komfort Grip

Add the B&G Komfort Grip handle to your sprayer.

- Reduce fatigue
- Non-slip grip
- Feels great
- Identify product
- Great for replacements



DESCRIPTION	ORDER #
Komfort Grip Handle	22029800

Quick Connect Kit **NEW**

- Quick change-out of valves in the field
- Use to prevent freezing of valve in the winter by removing valve from the sprayer



DESCRIPTION	ORDER #
Quick Connect Kit	22071825

B&G Cleaning Kit

Extend the life of your B&G Sprayer with the B&G cleaning kit.

- Less down time
- Better application
- Specially designed for use with B&G Sprayers
- Improve productivity

DESCRIPTION	ORDER #
B&G Cleaning Kit	22049625



TERMITE CONTROL

See a video of these products in action @ www.bgequip.com

Series 400 Termite Tools

When was the last time you upgraded your termite tools? B&G Series 400 Termite Tools puts you in control of termite treatment costs. Apply the correct amount of termiticide every time, in precise locations. Reduce technician fatigue. Do it right the first time with our complete sets of termite tools.

- Pick an easy-operating valve from the selections below
- Pick a pipe set from the selection on the right
- 4 precision delivery tips included
- Quick change adapters are standard on all pipes
- Custom tools built to fit your specific needs
- Designed to meet current labeling requirements of termiticides

Choose A Valve

Versagun

BEST VALVE AVAILABLE

- Best termite valve in the business
- “Balanced” trigger for less operator fatigue



Robco QCG

- Pressure gauge port at valve
- Stainless steel and brass construction
- Easily converts to a perimeter spray gun



Versatool

- “Old Reliable”
- Economical and durable



Choose A Pipe Set

Standard

Professional

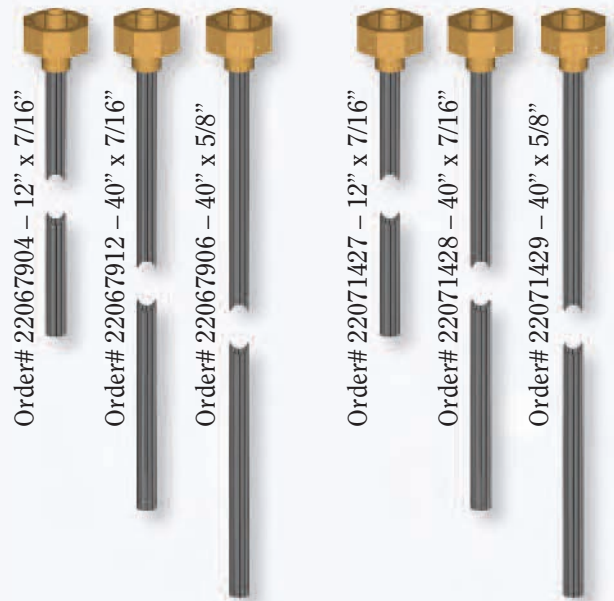

Order# 22067904 – 12” x 7/16”

Order# 22067912 – 40” x 7/16”

Order# 22067906 – 40” x 5/8”

Order# 22071427 – 12” x 7/16”

Order# 22071428 – 40” x 7/16”

Order# 22071429 – 40” x 5/8”

Standard Pipes

- All 7/16” pipes – stainless
- 5/8” Rodding pipe – galvanized
- Variety of lengths for all applications
- Comes complete with foot ram assembly

Professional Pipes

- Maximum durability
- Constructed of stainless steel tubing
- Built in check valve for drip free application
- Stronger
- Comes complete with foot ram assembly

Standard Tip Kit

- Designed for a wide range of applications
- Stainless steel construction
- Tips are calibrated at 20 psi
- Wide variety of sizes
- Precision machined





457 451 453 454

STYLE	7/16” TIPS	5/8” TIPS (SOIL RODDING)
	2 gpm	2 gpm
360°	Model 451 11007451	Model 454 11007454
180°	Model 453 11007453	Not Available
VOID TIP	Model 457 11007457	Not Available

Termite Tool Kits

KIT #	ORDER #	VALVE	PIPE SET	TIP SET	NOTES
410	11007410	Versatool	Standard	Standard	Basic Tool
415	11007415	Versatool	Pro	Standard	Deluxe Kit with Versatool valve & tip shutoff
420	11007420	Robco QCG	Standard	Standard	Same as 4 in 1 Tool except no 4" pipe
425	11007425	Robco QCG	Pro	Standard	Deluxe Robco Tool with tip shut off
430	11007430	Versagun	Standard	Standard	Entry level Versagun tool
435	11007435	Versagun	Pro	Standard	Our best tool kit – great for all applications
484	11007375	Versatool	1340 Pipe	Special	Slab Injector

Sub-Slab Injectors and Rodding Tools

		RODS	TIPS
SUB SLAB INJECTOR SSI-4	 Versatool Valve – Order # 11005965	Tool Height #4 = 18" Internal Rod 1/2"	<ul style="list-style-type: none"> ■ 360° (2 gpm) ■ 180° (2 gpm) ■ Tip shut-off
SUB SLAB INJECTOR SSI-14	 Versatool Valve – Order # 11005985	Tool Height #4 = 28" Internal Rod 1/2"	<ul style="list-style-type: none"> ■ 360° (2 gpm) ■ 180° (2 gpm) ■ Tip shut-off
ROBCO SOIL RODDING TOOL	 Robco QCG Valve – Order # 22067703	5/8" x 40"	Model 454 tip

The right tools to do the job RIGHT!

Features and Benefits

- Wide variety of models
- Designed to meet current labeling requirements of all modern termiticides
- Certified accurate
- 360° tips spread about 12" in soil
- Versatile

Repair Kits and Accessories

DESCRIPTION	MODEL #
Repair Kit – Versagun	22067554
Repair Kit – Versatool	22028910
Quick change adapter for void pipes	22067797
Repair Kit – Robco SRG	22067848
Replacement Cone Seal	22071771

Optional Termite Tool Tips and Extenda-Pipes

FITS ALL SERIES 400 TERMITE TOOLS	
360° Tip	Model # 450 Order # 11007450
180° Tip	Model # 452 Order # 11007452
5/8" x 40" Pipe	Model # 465 Order # 11007465
7/16" x 40" Pipe	Model # 460 Order # 11007460

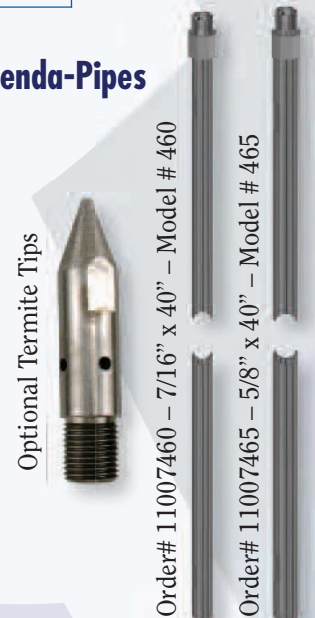

COMPACT SPRAYER

See a video of these products in action @ www.bgequip.com

AccuSpray **NEW**

The AccuSpray is an important tool for any IPM Program. The compact design allows insecticide to be applied to areas where insect activity is present. There are many models and configurations available.

AccuSpray Professional

- Brass Extenda-Ban valve
- All metal bottle
- Heavy duty hose assembly
- Wide variety of tips
- Deluxe holster

AccuSpray

- 16 oz. capacity
- 6' coiled hose
- High efficiency pump – less than 10 strokes to pressurize
- Push button trigger provides fine spray and includes a C&C straw



AccuSpray Professional spare bottle and cap

AccuSpray Professional

AccuSpray Professional shown in deluxe holster





AccuSpray shown in B&G carry pouch



Use the AccuSpray Professional with the new IPM Case. See page 12 for more details.

ACCUSPRAY PROFESSIONAL TIP CONFIGURATIONS AVAILABLE

B&G 4-Way Tip with Crack & Crevice Straw	
Termite Injection Tip	
Crack & Crevice Straw Tip	

DESCRIPTION	MODEL #
AccuSpray with Push Button Trigger Valve	24000040
AccuSpray Professional – 4-Way Tip with Crack & Crevice Straw	24000100
AccuSpray Professional – Crack & Crevice Straw Only	24000102
AccuSpray Professional – Termite Injection Tip	24000101
Tip Kit for 24000040	24000031
Spare Bottle and Cap	24000115
Seal and Gasket Kit (AccuSpray Professional)	24000037
Rebuild Kit (AccuSpray)	24000001

AEROSOL DELIVERY

See a video of this product in action @ www.bgequip.com

Aerosol Delivery Unit

Aerosol delivery just got easier at half the price of competitive units.

- Works with CB Products™ and *BASF™ products
- Promotes professional image
- Quickly snaps on can with no leaking of propellant
- Easy to use on/off valve
- 6' coiled hose
- Sure seal design – no continual seal replacement necessary

ADU with blue hose is for CB Products™



Easy to use on/off valve
Simply push inner ring and click outer ring. You're attached and ready to go!



New Holster Design

DESCRIPTION	ORDER #	MODEL #
CB Products™ Compatible	24000030	ADUWA
BASF™ Compatible	24000050	ADUWM
Injection Unit fits CB Products™	24000075	ADUWA (WIT)
Injection Unit fits BASF™ Products	24000076	ADUWM (WIT)
Standard Holster	24000073	
Deluxe Holster	24000072	

ADU with blue hose and red stripe is for BASF™

ADU shown with injection tip



Holsters

Increase your professional appearance. Carry your aerosols using B&G holsters.

- Chemical resistant high wear material
- Belt loop for easy access
- Pockets to conveniently hold straws
- Heavy duty construction and economically priced

B&G deluxe holster shown

* BASF is a registered trademark of the BASF Corporation.
* CB Products is a registered trademark of the FMC Corporation.

AEROSOL DELIVERY

See a video of these products in action @ www.bgequip.com

Portable Aerosol System

The B&G ULV Portable Aerosol System gives you deep wall void penetration, crack and crevice along with localized fogging capabilities and costs much less than competitive equipment. It has the capability of also doing a liquid only application for crack and crevice work or an air only application for use in a flushing operation.

- One gallon stainless tank, can be easily removed from case for cleaning or filling
- Brass and stainless steel gun with your choice of 9" or 18" extension
- 10' self coiling hose (15' on commercial units)
- Unit can be removed from case for spot treatments
- Many models available, including a commercial version, which features a fan cooled compressor along with a 15' hose
- Liquid pressure is adjustable to give you from a heavy mist to ULV fog
- All units are field repairable—no need to return the unit for service
- Save 90% on the cost of purchasing aerosols in a can—create your own with the Portable Aerosol System.



ULV Portable Aerosol Unit shown in cut-away view

Priced at half the competition and great for all applications from bedbugs to commercial kitchens to general pest.

DESCRIPTION	ORDER #
Unit with 9" Extension	16290000
Unit with 18" Extension	16300000
Commercial Unit with 9" Extension	16270000
Commercial Unit with 18" Extension	16400000
Cart-Mounted Portable Aerosol System	12011030

220V Models Available. Contact B&G for more information.

NEW

Versaduster

Now use your PAS or Versafoamer as a power duster. Comes as a complete kit and simply plugs in. Great for commercial kitchens or bedbug treatments. See page 18 for more information.



DESCRIPTION	ORDER #
Versaduster Kit	24010901
Spare Bottle and Tips	24011902

Cart-Mounted Portable Aerosol System

Same great features as the case-mounted unit except in a cart-mounted version.

- 3 gallon stainless tank for extra capacity
- Easy to use and clean
- 15' self-coiling hose
- 18" stainless steel extension and tip



IPM CASE

See a video of this product in action @ www.bgequip.com

AccuSpray Professional



B&G IPM Case and Kits

The new IPM Case instantly lets your customer know that you are a professional. Use it to organize all your IPM application tools so you'll not only look like a professional, but work like one, too!

- Outer zipper pocket holds frequently used items like insect monitors & bait stations
- Inner zipper compartment organizes bait tubes and bait gun
- Pockets on each side can hold Aerosols or AccuSpray units
- Inside the case can be customized using the adjustable dividers to hold anything from spare aerosol cans to spare dust bulbs to monitors
- D-rings keep B&G Bulb Duster, your cell phone and accessories within easy reach
- Rear Velcro® flap pocket holds laptop, clipboard, labels & sales information



**New reinforced design.
Can now be used with the
AccuSpray Professional.**

B&G IPM Case Available 2 Ways



Case Only—Use your own IPM tools



Kit—including ADU, AccuSpray, Bulb Duster and Lo-Line Monitors

DESCRIPTION	ORDER #
IPM Kit with CB Products™ ADU	45000131
IPM Kit with AccuSpray Professional	45000132
IPM Kit with BASF™ ADU	45000151
Case Only (No IPM Components)	45000165

* BASF is a registered trademark of the BASF Corporation.
* CB Products is a registered trademark of the FMC Corporation.

FOGGING EQUIPMENT

See a video of these products in action @ www.bgequip.com

Heavy-Duty Foggers

B&G foggers have motors available in both 110V/60Hz or 220V/240V. Tank is rotationally molded and has seamless design for maximum strength. Made of corrosion resistant materials for use with many chemicals. 1 to 1.5 gallon capacity with 3-1/2" wide tank opening.



My-Ti-Lite 2300

- Ideal for general treatment with insecticides
- Insecticide discharge of approximately 9 oz/minute
- Non-adjustable
- Non-ULV



Ultra-Lite 2400

- Adjustable flow rate up to 0–2.5 oz/minute
- Variable delivery from ULV droplets to mist
- Economically priced yet very effective
- ULV



Flex-A-Lite 2600

- Adjustable flow rate up to 0–2.5 oz/minute
- Extension hose is 18" long
- Variable delivery from ULV droplets to mist
- Ideal for fly control indoors
- ULV



DESCRIPTION	ORDER #	MODEL #
My-Ti-Lite Fogger	15015000	2300
Ultra-Lite Fogger	15015100	2400
Flex-A-Lite Fogger	15014901	2600

For 220V models, please contact B&G for order numbers.

FOAMING EQUIPMENT

See a video of this product in action @ www.bgequip.com

Versafoamer HH

- Just hand pump and foam
- Great for wall voids and drains
- Stainless steel tank
- Heavy-duty construction
- Excellent for termites, ants or small flies
- Portable and easy to use
- No adjustments, makes great foam every time
- Most parts interchangeable with standard B&G parts
- Economically priced

DESCRIPTION	ORDER #	MODEL #
Versafoamer HH	11007360	HH
Gasket and Rebuilt Kit	22049600	GT-100



Securely holds your foamer in place in your service vehicle.

NEW

Sprayer Caddy

Mounts in your service vehicle and holds your foamer firmly in place. Helps prevent damage or chemical spillage during transportation.

- Heavy duty metal construction
- Chip resistant finish
- Mounting holes for either side or bottom mounting



DESCRIPTION	ORDER #
Caddy – 1 gallon & 5 liter (tall)	11009850
Caddy – 2, 3 gallon & 5 liter (short)	11009860

Optional Tips



DESCRIPTION	ORDER #
Optional Drain Tip	16200023
Optional Straight Tip	16200018
Curved Tip (included with unit)	16200013

FOAMING EQUIPMENT

See a video of these products in action @ www.bgequip.com

Versafoamer 4000

The B&G Versafoamer 4000 is an easy to use power foamer and can be used in a wide variety of foaming applications. It's made of heavy duty components and designed for years of dependable service.

- Electric, compressed-air system
- 1 gallon tank with pressure gauge
- Completely contained in leak-proof case
- No adjustments, great foam every time
- Quiet compressor motor, 7' hose
- Treat wall and cabinet voids
- Portable and easy to use



DESCRIPTION	ORDER #
Versafoamer	16201003
220V Versafoamer	16201002

Optional Tips



DESCRIPTION	ORDER #
Optional Drain Tip	16200023
Optional Straight Tip	16200018
Curved Tip (included with unit)	16200013

ULV Portable Aerosol Unit / Versafoamer Combo Unit

Combine a PAS with a Versafoamer 4000 to create a totally flexible pest control system. Use just one case and compressor and easily change out tank and valve for each different application. An economical solution for a foamer/aerosol combo unit.



DESCRIPTION	ORDER #
Commercial PAS-9" Extension with Versafoamer 4000	16500009
Commercial PAS-18" Extension with Versafoamer 4000	16500018
Standard PAS-9" Extension with Versafoamer 4000	16600009
Standard PAS-18" Extension with Versafoamer 4000	16600018

220V Models Available. Contact B&G for more information.

SPECIALTY SPRAYERS

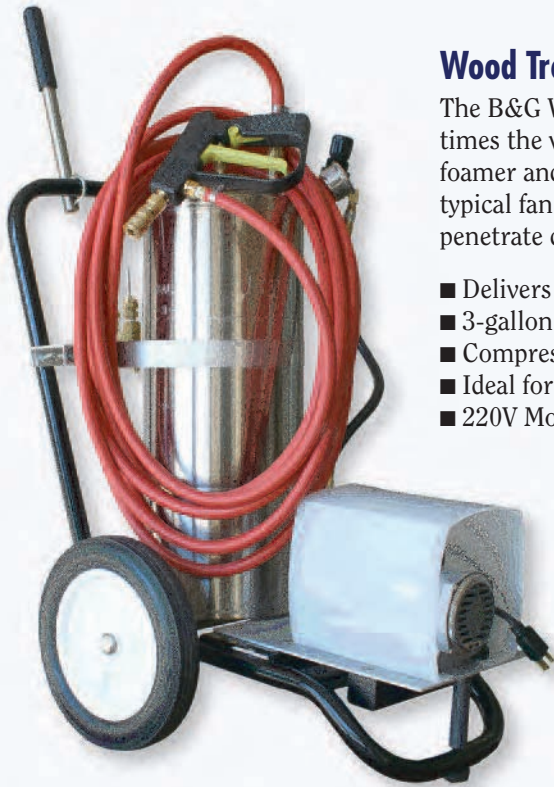

Wood Treatment System (WTS)

The B&G Wood Treatment System produces 10-15 times the volume of liquid as compared to a traditional foamer and 5 times more capacity as compared to typical fan sprays. This ensures that the chemical can penetrate deeper than any other method.

**Creates Both
Foam & Liquid**

- Delivers liquid or foam insecticide
- 3-gallon tank, 30' or 50' hose
- Compressor maintains tank pressure, adjustable to 50 psi.
- Ideal for pre-treatments of structural wood, sub-slab re-treatments for termites
- 220V Models available. Contact B&G for more information.

DESCRIPTION	ORDER #
30' of hose, single surface tip, and wall void tip	24040000
50' of hose, cart handle extender, single 6" surface tip, wall void tip, dual 10" surface tip, and pressure injection tip	24040001

QT-1 Sprayer

- Ideal for applying microbial cleaners or other chemicals
- Liquid and foaming models – 1.5 liter capacity
- Great for spot treatments
- High quality construction with Viton® seals

DESCRIPTION	ORDER #
QT-1 with FN-2280 Foam Tip	17017408
QT-1 with 5700-B Tip	17017404
QT-1 with SST Inject Tip	17017403
QT-1 with Adjustable Tip	17017401
QT-1 with Fan Tip	17017407

* Viton® is a registered Trademark of Dupont Performance Elastomers.



SRG Perimeter Spray Gun

- High quality – Made in U.S.A.
- Stainless steel and brass with interchangeable nozzles
- Adjusts from cone spray to straight stream, drip free shut-off
- Rugged construction will give long, trouble-free service
- Ideal for pre-construction termite treatments
- Converts to a termite tool



GALLONS PER MINUTE – WIDE ANGLE AND STRAIGHT STREAM

TIP No.	40 PSI SETTING		100 PSI SETTING		200 PSI SETTING		400 PSI SETTING		ORDER No	MODEL No.
	W	S	W	S	W	S	W	S		
6	1.1	1.2	1.7	1.8	2.5	2.6	3.5	3.7	22067701	SRG-6
12	3.9	4.4	6.2	6.9	8.7	9.8	12.3	13.8	22067897	SRG-12

DUST APPLICATION

See a video of these products in action @ www.bgequip.com

Electric Dust / Granular Applications

An Electric Dust/Granular applicator that is ideal for applying a large volume of material consistently over a broad area.

- Chamber holds 3 lbs. of dust or granules
- Extension adds a static charge to the dust
- Flexible 1' hose to direct material to target
- Available in 110V or 220V
- 12" direct application attachment



DESCRIPTION	ORDER #	MODEL #
110V Electric Duster	15015605	2250
12" Extension	29108459	2259
Long Reach Granular Dust-R	24050000	1153-G
Mini Dust-R	11005850	1151-M
Hand Dust-R	11005800	1152-A

220V Models available. Contact B&G for more information.

Long Reach Granular Dust-R

- Chamber holds 2 quarts of dust
- Ideal for treating attics and crawl spaces
- Great for treating wasp nests
- 3-14" extensions
- Extension adds a static charge to the dust



Mini Dust-R

- Chamber holds 0.5 lb. of dust, 7 oz. of granules
- Large opening for easy filling and emptying
- Ideal for Silica-based dust formulations
- Consistent delivery of granules
- Tip kit included for all applications
- Great for most dust applications



Hand Dust-R

- Chamber holds 2 quarts of dust
- Extension adds a static charge to the dust
- Ideal for treating attics and crawl spaces
- Includes 12 inch extension with 90° off-set at end of the tube
- Variety of tips available



VERSADUSTER **NEW**

The new Versaduster from B&G is a very reliable power duster at an economical price. Great for all dust applications from commercial kitchens to bedbug treatments.

- No batteries required
- Easily serviced
- Economically priced
- 40' recoiling hose
- Easy to fill
- Heavy duty XR Gun
- Works with all dust formulations
- Easily plugs into any power source
- Heavy duty design built for years of dependable service
- "No Clog" design applies a dust application with each pull of the trigger
- Can be purchased as a kit (without compressor) for use with a PAS or Versafoamer



Heavy duty fan cooled compressor unit for long service life. Electrical connection is made by use of a standard extension cord.



Dust output is adjustable from a very fine to a heavy application.

Adjustment knob to control dust output.

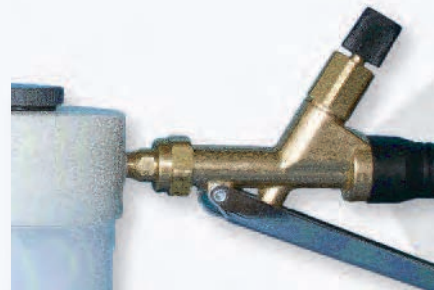

Download a copy of our new Technical Manual on Dust Application at www.bgequip.com



The Versaduster comes with a large and small dust bottle and a variety of tips.

DESCRIPTION	ORDER #
Versaduster System Complete – 110V	24010900
Kit (no compressor) – Use with PAS or Versafoamer	24010901
Spare Bottles and Tips	24011902
Tip Kit	24010904

See a video of these products in action @ www.bgequip.com

PestPro 2000 Backpack Sprayer

An economical and dependable backpack designed for the Pest Control Professional.

- 4-Way tip model meets new regulations on perimeter applications for pin stream application around doors and windows, and 3' fan spray of building foundations and soil
- Tip shut off for drip free application
- Dual position handle (right or left)
- Deluxe comfort shoulder strap
- Ideal for perimeter applications
- Piston pump mechanism

Includes 4-Way Tip



DESCRIPTION	ORDER #	MODEL #
PestPro 2000 with Adjustable & Fan Tips	12014210	PPRO1
Pest Pro 2000 with 4-Way Tip	12014240	2050

XR-Valve

- Most durable in the industry
- Comfort grip handle



Bulb Duster

- Excellent for granular or dust applications
- Flexible base on extension for hard-to-reach areas
- B&G quality – heavy-duty construction
- Extra tip extension for hard to reach areas
- Extension doubles as siphon tube if needed
- Self-sealing – no need for gaskets
- All plastic tips used for "No Worry" application around electrical outlets
- Belt clip
- Superior dust delivery



DESCRIPTION	ORDER #	MODEL #
Bulb Duster	11005810	1150
Tip Kit	11005811	DB-KIT

Tip Kit

- Can be used as extensions for many of our dust and granular products
- All plastic construction



MONITORS & BAIT STATIONS

See a video of these products in action @ www.bgequip.com

TM-1 Termite Monitor

Provides a Valuable Service

Constantly monitors your customer's premises for possible termite presence. Allows you to address any termite activity immediately before any damage occurs.

Increased Customer Retention

On a daily basis it gives your customer a reminder of the valuable service you provide. The B&G TM-1 Termite Monitor can be custom printed with your company information.

Increased Sales

Offers you the opportunity to supply a Termite Monitor Program as an "add on" service. When termite activity is present permits you the opportunity to immediately sell a termite protection and remediation program.

Inexpensive and Easy to Install and Service

The B&G TM-1 Termite Monitor is easy to install – no drills or augers are required. Servicing takes less than a minute and at a cost of less than \$2.00 per monitor, it allows you to offer an invaluable service in a cost effective termite monitoring program.



Shown in open view

Give us a call at 800-544-8811 and we can help you put together a termite monitoring program.

DESCRIPTION	ORDER #
TM – 48/carton, green (plain)	26000004
TM – 48/carton, brown (plain)	26000005
Cardboard Insert (100 pieces)	26000009
Stake Kit (90 pieces)	26000013
TM – 48/carton, green (plain) pallet quantity	26000100
TM – 48/carton, brown (plain) pallet quantity	26000101
TM – 48/carton, green (printed) pallet quantity	26000102
TM – 48/carton, green (printed) half pallet quantity	26000104

Outdoor Insect Bait Station

The ultimate system for monitoring and baiting.

- Accessible to crawling insects, including ants
- Holds liquid, granular, paste, and gel baits
- Season-long control method for IPM programs
- Patented design

Ants-Only Bait Station

- 4 compartments for liquid or granular bait
- Allows only ants to enter and leave with bait
- Holds enough liquid bait for colony control

DESCRIPTION	ORDER #	MODEL #
Green Cap – 100 units	24030111	PPS-1
General Pest Bait Station – base, 100 units	24030110	PPS-2
Ants-Only Bait Station – 100 units	24030188	PPS-2A
3" Ground Spike – 100 units	24030113	PPS-3
6" Ground Spike – 100 units	24030114	PPS-6

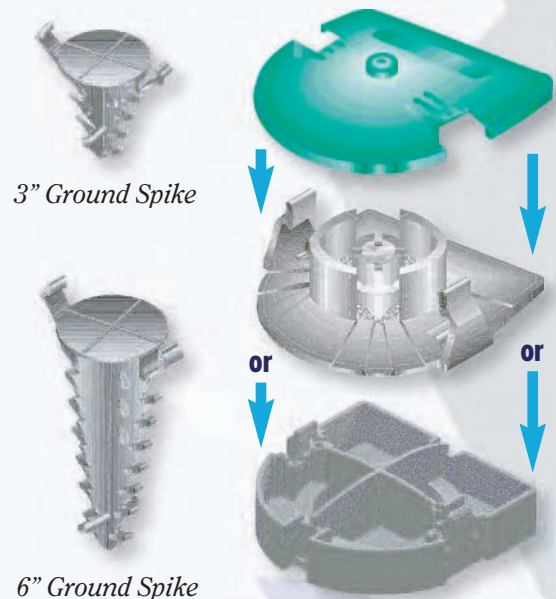

RODENT CONTROL

See a video of this product in action @ www.bgequip.com

FAST CATCH **NEW**

The first true IPM rodent station.

The Fast Catch can be used in IPM programs for monitoring with non-toxic bait and then when activity is present a snap trap can be used for final control. It can also be utilized as a “stand alone” snap trap or rodent bait station.

The Fast Catch station is available in two different models, the first is a station-only design and the second is our “Rodent Alert” design. This Patent pending design features a “pop up” alert that will notify you that the snap trap has been triggered.

- Heavy duty poly construction
- Easy open single lock design
- Reusable – designed for years of service
- Tamper resistant – lid recesses into base
- Low profile design for increased rodent activity
- Fits all professional rat snap traps and includes bait rods
- Long entry pathways keeps the rodent hidden after catch
- Can be used in a variety of applications
- Pop-outs in rear of station allows for attachment to pipes or any other object by use of cable ties

Can be used with snap traps, bait, or a combination of both.

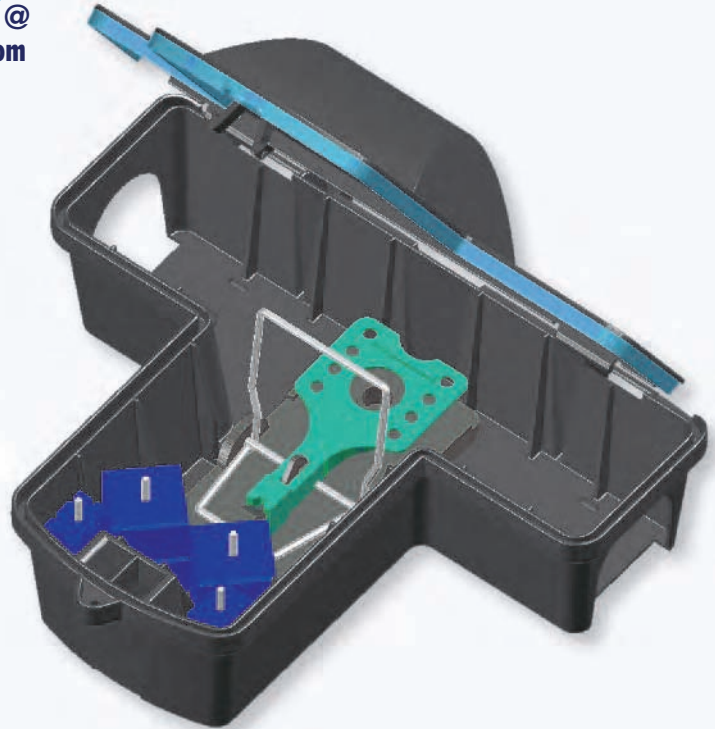

Great places to use the Fast Catch:

- Sensitive Accounts – where rodenticide is banned
- Residential Accounts – keeps rats hidden from occupants
- Commercial kitchens, restaurants and office complexes

DESCRIPTION	ORDER #
Fast Catch Station With Rodent Alert	25000309
Fast Catch Station	25000308
Extra Key Pack – 15 Keys	25000205
Attachment System Kit	25000260-C
Fast Catch 6 Pack with Attachment System	35000308
Fast Catch Alert 6 Pack with Attachment System	35000309

Rodent Station Attachment System

Technical specifications:

- Attaches any B&G rodent station to a 12”x12” paver block
- Installs in less than 30 seconds
- Heavy duty metal construction
- Patent pending design
- Economical cost

Special features:

- The station attachment system consists of 2 clamps, a metal screw and washer. It is designed for use with a 12”x12” (1.5” thick) concrete paver, and only with B&G rodent stations
- Easy and economical way to secure the Fast Catch and rodent bait station
- Holds station securely to block and is reusable

Pop-Up Alert

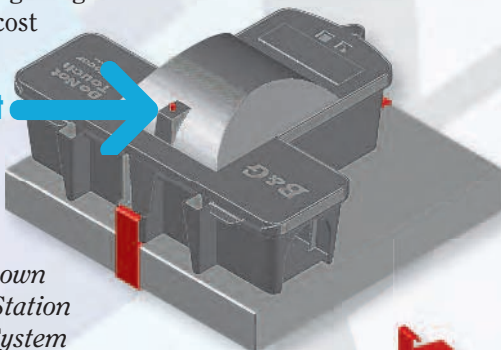

Fast Catch shown with Rodent Station Attachment System

To see a video of the Attachment System, visit us on the web at www.bgequip.com

BAIT GUN & CARRY CASES

See a video of these products in action @ www.bgequip.com

Multi-Dose Bait Gun **NEW** Suggested List Price Below \$50

- Consistent delivery with each trigger pull
- Works with most baits
- Patented plunger design eliminates drip at the tip
- Range of bait placement sizes available from calibrated knob
- Precision application of gel baits for cockroach and ant control
- Saves you money on wasted bait due to over application when using generic bait guns
- Deluxe holster



Multi-Dose Bait Gun shown in deluxe holster



Contact B&G for a copy of the new technical report on bait gun economics.

DESCRIPTION	ORDER #	MODEL #
Multi-Dose™ Gun Kit Includes gun, extra syringe and syringe tip	24020001	3000
Multi-Dose™ Basic Kit Gun with no accessories	24020002	3000-B
Multi-Dose™ Gun Deluxe Kit Includes model 3000 and holster	24020000	3000-DL

B&G Carry Cases

B&G carrying cases are rotationally molded for years of durability.

- Seamless construction, no leaks
- Child-resistant lock
- Holds B&G tank sprayers and other equipment
- For full listing of colors and sizes available, please contact B&G

DESCRIPTION	ORDER #	MODEL #
Compact Case with Lock 16-1/2" x 9-3/4" x 16-1/2" (39 cm x 24 cm x 41 cm)	Junior Case	763
Jumbo Case with Lock 16-3/4" x 14" x 19-1/4" (42 cm x 35 cm x 48 cm)	Jumbo Case	760



Jumbo Case



Junior Case

Additional colors available



FLY CONTROL

Matrix II Light Trap

Built to industrial standards and designed for years of dependable service, the Matrix II is one light trap worthy of the B&G name.

The Matrix II with its 4 bulb configuration and heavy duty metal construction makes it the most powerful and durable light trap available.

- Up to 100 watts of UV light
- 1 or 2 glue board configuration
- Attracts insects from two sides
- Most powerful trap available
- Available in white or black
- Mount on wall, or hang using concealed handles
- Shatterproof bulbs available
- Dimensions: 21" x 14" x 5"



DESCRIPTION	ORDER #	MODEL #
Matrix II Unit – Black	17050063	FM-4
Matrix II Unit – White	17050150	FM-4 White
Matrix II Glue board, 24/case	17050055	FM-4B
Matrix II Replacement Bulbs, 24/case	17050053	FM-4-BULB

Window Trap / Bait Station

- Fill with fly bait and the unit becomes a fly bait station
- Uses natural UV light as attractant
- Equipped with double sided tape for securing to any surface
- Base remains in place with removable top for ease in servicing
- Great to use in restaurants and fast food eating area to catch flies and wasps
- Holds 1 or 2-sided pheromone treated glue board, easy to install and replace



Disposable Window Fly Trap

- Great for offices, restaurants and residential
- Glue board treated with pheromone lure
- Economically priced
- Great size 4-1/4" x 9"
- Black glue board hides the fly catch
- Excellent catch rate – Highly effective

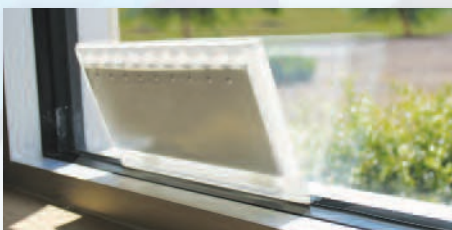

Liquid Wasp and Fly Attractant

Ideal for yellowjackets and fruit flies. It is one of the best lures you can use that does not allow flies to breed.

- Long-lasting attractant for flies, wasps, and yellowjackets
- Concentrated formula, attracts insects at long distance
- Use in a Dome Trap for wasp control in backyards



DESCRIPTION	ORDER #	MODEL #
Disposable Fly Trap – 4/Box	14001081	DWT-2000
Disposable Fly Trap Master Pack – 40/Box	14001120	DWT-2040
Fly/Wasp Attractant – 12/Pack	14001082	Liq-Wasp-12
Window Trap – 10/Pack	14001220	WT-10

LO-LINE MONITOR



Cockroach Trap & Insect Monitor
 Unlike competitors that put attractant in their glue, B&G uses a new highly proprietary process that actually applies a layer of attractant before the glue is applied. This provides the highest level of attraction to the insect.

- Ideal as monitor in IPM programs
- Highly effective glue for positive catch rates
- Promotes “Green” pest control
- Great for IPM programs
- Private label available
- Large trap with a low profile, fits under tables and in confined spaces
- Design prevents cockroaches and insects from escaping
- Food based attractant is safe yet very effective for all insects including cockroaches, silverfish, spiders, centipedes and earwigs.

Openings in side generate increased attraction by allowing air to flow through the trap.



ALL NEW!
Ready-to-use model!
NO TABLETS!



Ramp design improves catch rate.

Use in sensitive accounts where use of insecticides is limited or prohibited.

THE LO-LINE IS SHOWN TO BE A HIGHLY EFFECTIVE BEDBUG MONITOR AND TRAP
 BedBug Central recently reported, “The performance of the Lo-Line Monitor has become noteworthy in bedbug treatment when compared to other general pest interception devices. During field testing of the Lo-Line this interception device has shown to have the greatest recorded efficacy in capturing bedbugs than other similarly purposed glue boards.”

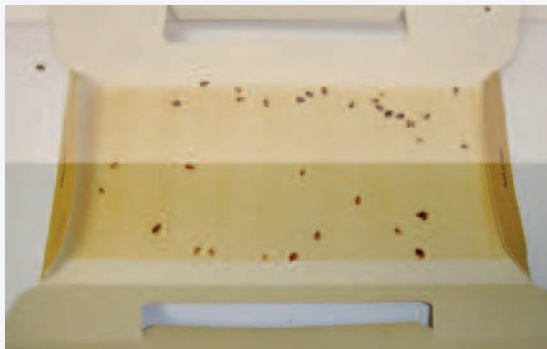

Actual bedbugs trapped by the Lo-Line Monitor



Technical Report available on how to use the Lo-Lines for effective control and monitoring. Request your copy today or download from www.bgequip.com

DESCRIPTION	ORDER #	MODEL #
Lo-Line Traps – 10 Pack	14001066	LL-10-L
Lo-Line Traps – 200 pack	14001068	LL-200-L
Advanced Control (includes tablets) 10 Pack	14001071	AC
Advanced Control (includes tablets) 200 Pack	14001072	AC

MONITORS, TRAPS & GLUE BOARDS

Detector Traps

- Unique design keeps two edges flush to wall and floor
- Highly effective food grade attractant
- Easily divided into three small traps
- Use for monitoring crawling insects
- Promotes “Green” pest control
- Private label available



DESCRIPTION	ORDER #	MODEL #
Detector 30 Pack	14001062	DET-30-L
Detector 600 Pack	14001063	DET-600-L

ALL NEW! Ready-to-use Model!

Indian Meal Moth Traps

An economical but highly effective alternative to other traps. The SP Locator is priced 75% lower than the competition!

<p>INDIAN MEAL MOTH FAMILY</p> <p><i>Plodia interpunctella</i> and <i>Ephestia spp.</i></p> 				
	10 LURES (LURE ONLY)	100 LURES (LURE ONLY)	SP LOCATOR TRAPS	DIAMOND TRAP KITS
	IMM-10 #14001003	IMM-100 #14001004	SP-IMM-20 #14001051	DIA-IMM-10 #14001044

Replacement Glue boards

B&G has replacement glue boards for every major trap used in the U.S. at half the price.

- Glue boards for all brands of light traps
- As effective as OEM replacement boards
- Advanced glue formula resists UV light degradation
- All glue boards treated with pheromone lure



Save money on replacement glue boards!

DESCRIPTION	ORDER #	MODEL #
B&G Matrix, all Pest West models, Gilbert Sticky Fox, 24/Case	17050055	FM-4B
All Whitmire Vector models, 24/Case (B&G's only wet glue board – identical to Vector)	14001077	FT-6
Window Trap, 20/Case	14001129	TD-B-20

TECHNICAL SUPPORT

B&G Website

The B&G website is designed to serve the Pest Control Professional from Service Technicians to Technical Directors. On our site you will find:

- New product information
- Information and manuals on repairing current B&G Equipment
- Product programs and application techniques
- Current product catalogs and data sheets
- Streaming video of many B&G products

Come visit us on the web at
www.bgequip.com

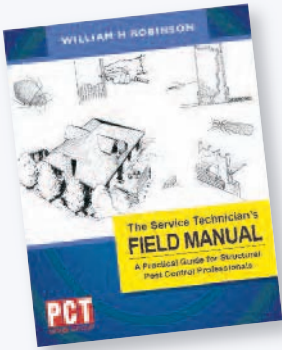

Service Technicians Field Manual

- Written for the Next Generation Service Technician
- Easy to read with page layout for studying and training
- 20 Chapters, over 235 technical illustrations
- Ideal for individual or company training sessions
- Only \$29.95. Call B&G at 800-544-8811, Ext. 102, to order your copy

B&G Training and Sales Material **ALL NEW**

B&G has a broad range of technical and sales information available for the Pest Management Professional.

- **B&G Product Showcase DVD**
- Application of Pesticides in Pest Control (Tech Manual)
- Termiticide application manual (CD)
- Care and Maintenance of the B&G Sprayer (DVD)
- Bedbug Training (DVD)
- Bait Gun Economics (Tech Manual)
- Master parts list and repair manual for most B&G Equipment

For a copy of any of this information, please contact B&G at 800-544-8811. Most of these programs and technical information are available for download from our website at www.bgequip.com



B&G Live Technical Support

Have an application question or problem? Need further information on a new product or have questions about existing B&G Equipment? Give us a call! We have a full staff of Technical Support Personnel, including former Pest Control Operators that can help you with any questions you have.

B&G Toll Free Support Line
800-544-8811



For over 60 years, B&G Equipment Company has been supplying equipment for the Pest Control Industry. B&G distributes throughout the world and is the leader in supplying superior equipment for the Pest Management Professional. B&G attributes their success to product innovation, cutting-edge design and unsurpassed quality.



135 Region South Drive • Jackson, GA 30233
www.bgequip.com • Toll Free 800-544-8811 • Fax 678-688-5633