



pelsis

*PRECISE.
POWERFUL.
DEPENDABLE.
WORLD-CLASS
EQUIPMENT.*

A FAMILY OF BRANDS WITH ONE SHARED PURPOSE

Our customers are on the front lines taking on pests, germs and other challenges that threaten peace of mind. That's why our products can't afford to fail. It's why we obsess over every detail and innovate with precise intention. Everything we do is to empower our customers with the best professional equipment in the world so they can get the job done to the highest potential.

WE ARE pelsis

To find out more about the Pelsis Group and our brands, visit pelsis.com

B&G

CURTIS DYNA-FOG[®] Ltd.

SYNERGETIC[®]

 **EDIALUX**
PROFESSIONAL PRODUCTS

NETWORK

P+L Systems[®]
Washroom

SILVANDERSSON 

AGRISENSE

BUILT ON A LEGACY OF BEING THE BEST IN PEST CONTROL.

We know how important the balance between control and extermination is. With our rich knowledge of the industry, history of innovative product development and expert technical support, our extensive product range is designed to ensure that pest professionals can select the right product for every pest problem. Our brands were born out of a need to create better equipment, and that same drive fuels our research, quality manufacturing and intentional innovation.

B&G

B&G designs and manufactures equipment based on in-depth knowledge of the pest control industry worldwide. The world-famous B&G tank sprayers have the highest quality stainless steel combined with special-grade brass, and chemical-resistant gaskets and hoses to provide durable and dependable service. They are the first choice of professionals throughout the pest control industry, with models to suit every application need.

CURTIS DYNA-FOG[®]

Known around the world for best-in-class disinfection and flying insect control equipment, Curtis Dyna-Fog continues to raise the bar. Their versatile catalog of products also features heavy-duty commercial foggers for large spaces, bird repelling and stored crops. Dyna-Fog equipment is trusted in nearly every corner of the world with endless versatility, dependable quality and masterful engineering.

SYNERGETIC[®]

Backed by patented technology and expert research, Synergetic[®] leads the flying insect control space in fly lights, bulbs and glue boards. Customers across North America stake their reputation on Synergetic products to rid spaces of flies, wasps and other flying insects. With innovative green light and LED technology, our products have been independently proven to attract a wider range of insects from farther distances.

CONTENTS.

08

SPRAYERS

- 10 Primeline Sprayers
- 12 Compact Sprayers
 - 12 AccuSpray Elite
 - 14 Spotsprayr
 - 14 QT-1 Sprayer
- 15 Specialty Sprayers
 - 15 Green Sprayer
- 16 Aerosol Delivery
 - 16 Aerosol Delivery Unit
 - 17 Portable Aerosol Systems
- 18 Sprayer Parts
- 22 Sprayer Accessories
 - 22 Pressurizing Tank Top
 - 22 Sprayer Caddy
 - 23 Comfort Grip
 - 23 Emergency Kits

24

FOGGERS

- 26 Hurricane ES
- 28 Hurricane Ultra
- 29 Cyclone Ultra
- 30 Tornado & Tornado Flex
- 32 My-Ti-Lite
- 32 Ultra-Lite 2400
- 33 Flex-A-Lite 2600
- 34 Backpacks
 - 34 Versa-Fogger
 - 35 Twister XL3

36

DUSTERS & DUST APPLICATION**38** Bulb Duster**38** Mini Dust-R**39** Hand Dust-R**39** Long Reach Granular Dust-R**40** Electric
40 110V Electric Duster
40 VersaDuster**41** Duster Parts & Accessories**42**

BAIT GUNS**44** Multi-Dose Bait Gun**45** Bait Gun Accessories**46**

FOAMING EQUIPMENT**48** VersaFoamer HH**49** VersaFoamer 4000**50**

TERMITE CONTROL**52** Wood Treatment System (WTS)**53** Termite Control Parts**56**

FLY LIGHTS**58** Glue Board Fly Lights

58 Infiniti

60 Halo

62 Edge

63 Flytrap Professional

64 Specialty Flylight

64 Halo Aqua

66 Decorative Fly Lights

66 Halo Curve

67 Nectar

68 Luralite Professional

69 Luralite CentoPlus

70 Flypod

71 Aura

72 Electric Grid Fly

72 Allure

73 Executor

74 FAQs**78** Product Selector**82**

RODENT CONTROL**84** Fast-Catch**85** Rodent Control Parts**86**

SERVICE CASES

SPRAYERS

PRECISE. POWERFUL. PROVEN.

Born from a need for better equipment, B&G Sprayers are the rock of the professional pest control industry. Trusted by pros around the world, our equipment is crafted to be dependable, easy to repair and versatile for any challenge on the job. Choose from our complete line to add the most reliable sprayers and accessories available to your operation.



PRIMELINE SPRAYERS

PRIMELINE SPRAYERS ICONIC FOR A REASON.

The B&G Primeline is known as the most reliable sprayer in pest control. Designed for years of dependable service, this iconic sprayer has the highest quality stainless steel combined with special-grade brass and chemical-resistant gaskets and hoses to take down any challenge, year after year. They are the first choice of professionals throughout the pest control industry, with models to suit every application need.

FEATURES

- .5-, 2-, 3-gallon and 5-liter capacity
- 9-inch, 18-inch and 24-inch extensions



PRIMELINE SPRAYERS

EXTENDA-BAN

FEATURES

- Extenda-Ban: Top quality valve for instant tip shut-off
- B&G 4 Way Tip: With fine fan, coarse fan, pin stream and either a Crack & Crevice Straw orifice (CC) or a second pin stream (S)



EXTENDA-BAN AND NEXT GENERATION VALVE

TANK CAPACITY	EXTENSION	MODEL #	ORDER #
2 Gallon	18"	N224-CC	11004300
1 Gallon	18" without C+C	N124-S-18	11003700
2 Gallon	18" without C+C	N224-S	11004200
2 Gallon	24"	N224-CC-24	11004375
1 Gallon	9" extension	N-124-CC Sprayer	11003900

XR VALVE

TANK CAPACITY	EXTENSION	MODEL #	ORDER #
1/2 Gallon	without C+C	N54-S	11001100
1 Gallon	9" without C+C	N104-S	11001400
1 Gallon	18"	N104-CC-18	11001460
1 Gallon	18" without C+C	N104-S-18	11001425
2 Gallon	18" with 8004 Fan Tip	N200-S	11001600
3 Gallon	18" with 8004 Fan Tip	N300-S	11001800

BAN-DRIP

TANK CAPACITY	EXTENSION	MODEL #	ORDER #
1/2 Gallon	-	N64-CC	11002090
1 Gallon	-	N114-CC	11002600

COMPACT SPRAYERS

Lighter and more portable, our compact sprayers go everywhere you go with ease.

ACCUSPRAY ELITE THE FUTURE IS HERE.

The AccuSpray compact sprayer (16 oz) is a great tool to bring along for any commercial or residential pest control job and is a terrific complement to the standard B&G tank sprayer. Use the crack-and-crevice straw and/or atomizing spray to treat the less-accessible, hard-to-reach spaces.

FEATURES

- Comes with a carry pouch that attaches to your belt
- Valve inserts into pouch for added convenience
- AccuSpray Elite model features stainless-steel bottle and heavy-duty hose
- Brass Extenda-Ban valve
- Wide variety of tips



COMPACT SPRAYERS

ACCUSPRAY ELITE - 4 WAY TIP WITH CRACK AND CREVICE STRAW AND NEXT GENERATION VALVE

- Light weight non-slip valve
- Made from Durable Polymer
- Termite injection tip available



ACCUSPRAY ELITE

ITEM #	DESCRIPTION	MODEL #	ORDER #
1	AccuSpray with Push-Button Valve	-	24000040
2	AccuSpray Elite – Extenda-Ban Valve with 4-Way Tip with C+C Straw	-	24000100
3	AccuSpray Elite – Next Gen Valve with 4-Way Tip with C+C Straw	-	24000200
4	AccuSpray Elite – Extenda-Ban Valve with C+C Straw Only	-	24000102
5	AccuSpray Elite – Extenda-Ban Valve with Termite Injection Tip	-	24000101
6	Tip Kit for AccuSpray with Push Button Valve	-	24000031
7	AccuSpray Spare Bottle and Cap	-	24000115
8	Gasket Kit for AccuSpray Elite	-	24000037
9	Repair Kit for AccuSpray	-	24000001

COMPACT SPRAYERS

SPOTSprayR

The sprayer for all specialty chemical applications.

FEATURES

- Chemical-resistant seals
- All metal bottle with brass spray tip
- Pin-to-cone nozzle
- High efficiency pump
- Belt holster



SPOTSprayR

ITEM #	DESCRIPTION	MODEL #	ORDER #
1	SpotSprayR	-	24000107

QT-1 SPRAYER

The perfect spot sprayer for all specialty chemical applications.

FEATURES

- Ideal for applying microbial cleaners or other chemicals
- Liquid and foaming models – 1.5 liter capacity
- Great for spot treatments
- Viton® seals



SPOTSprayR

ITEM #	DESCRIPTION	MODEL #	ORDER #
1	QT-1 with FN-2280 Foam Tip	-	17017408
2	QT-1 with 6" Plastic Straw	-	17017404
3	QT-1 with SST Inject Tip	-	17017403
4	QT-1 with Adjustable Pin-to-Cone Tip	-	17017401
5	QT-1 with Fan Tip	-	17017407

SPECIALTY SPRAYERS

Get a sprayer for specific applications or to easily identify organic, natural or specialty chemicals.

GREEN SPRAYER

Can be used with natural products, most common insecticides and non-repellant type products.

FEATURES

- Models with 9-inch or 18-inch extensions available
- Chemical-resistant hose
- B&G 4 Way Tip
- Green top and carpet protector ring



GREEN SPRAYER

ITEM #	DESCRIPTION	MODEL #	ORDER #
1	Green Sprayer 9" Extension, CC 4-Way Tip	-	11003917
2	Green Sprayer 18" Extension, CC 4-Way Tip	-	11003958

AEROSOL DELIVERY

Defined by ultra-fine, consistent droplets, aerosol sprayers ensure efficient and accurate delivery.

AEROSOL DELIVERY UNIT

FEATURES

- Works with *BASF™ products
- Promotes professional image
- Attaches to can top with no leakage
- Easy to use on/off valve
- 6-foot coiled hose
- Sure seal design

HOLSTERS

- Chemical and wear resistant material
- Belt loop for easy access
- Pockets to hold straws



AEROSOL DELIVERY UNIT

ITEM #	DESCRIPTION	MODEL #	ORDER #
1	BASF™ (WIT) / Standard	ADUWM	24000050
2	BASF™ (WIT) / Deluxe-Brass HDL	ADUWM	24000076
3	Standard Holster	-	24000073
4	Deluxe Holster	-	24000072

AEROSOL DELIVERY

PORTABLE AEROSOL SYSTEM (PAS)

Modern pest control requires more than one application method. Get deep wall penetration, along with crack-and-crevice and localized fogging capabilities in one ideal tool. The B&G ULV Portable Aerosol System is designed for adaptability, giving operators the option to integrate liquid and aerosol products in one application, or make use of each delivery method individually.



FEATURES

- Can be adjusted for delivery of a very fine ULV fog to a heavy mist to handle most applications
- 1-gallon tank can be removed from case for cleaning or filling
- Brass and stainless-steel gun with choice of 9-inch or 18-inch extension, 10-foot coiled hose on standard model
- Delivers both water- and oil-based formulations with low to moderate viscosity
- 10-foot hose provides mobility
- Adjustable flow rates: 4-10 oz/min
- At maximum flow rate (gauge 30 psi), droplet size is 40-50 microns, droplet throw 15 feet with effective distance of 10 feet
- Coverage: 20 sq ft (at 30 psi)

PORTABLE AEROSOL SYSTEM (PAS)

ITEM #	DESCRIPTION	MODEL #	ORDER #
1	PAS with 9" Extension	-	16290000
2	PAS with 18" Extension	-	16300000
3	Commercial PAS with 9" Extension	-	16270000
4	Commercial PAS with 18" Extension	-	16400000

PORTABLE AEROSOL SYSTEM (PAS), CART MOUNTED

FEATURES

- Three-gallon stainless tank for extra capacity
- 15-foot coiled hose
- 18-inch stainless steel extension and tip
- Delivers both water- and oil-based formulations with low to moderate viscosity
- Adjustable flow rate: 4-10 oz/min
- At maximum flow rate (gauge 30 psi) droplet size is 40-50 microns, droplet throw 15 feet with effective distance of 10 feet
- Coverage: 20 sq ft (at 30 psi)



PORTABLE AEROSOL SYSTEM (PAS), CART MOUNTED

ITEM #	DESCRIPTION	QTY PER CASE	MODEL #	ORDER #
5	Cart-mounted PAS with 18" Extension	1	-	12011030

SPRAYER PARTS

Find B&G Sprayer Parts to upgrade or rebuild your equipment. Our tanks and sprayers are expertly engineered for maximum compatibility and easy repairs.

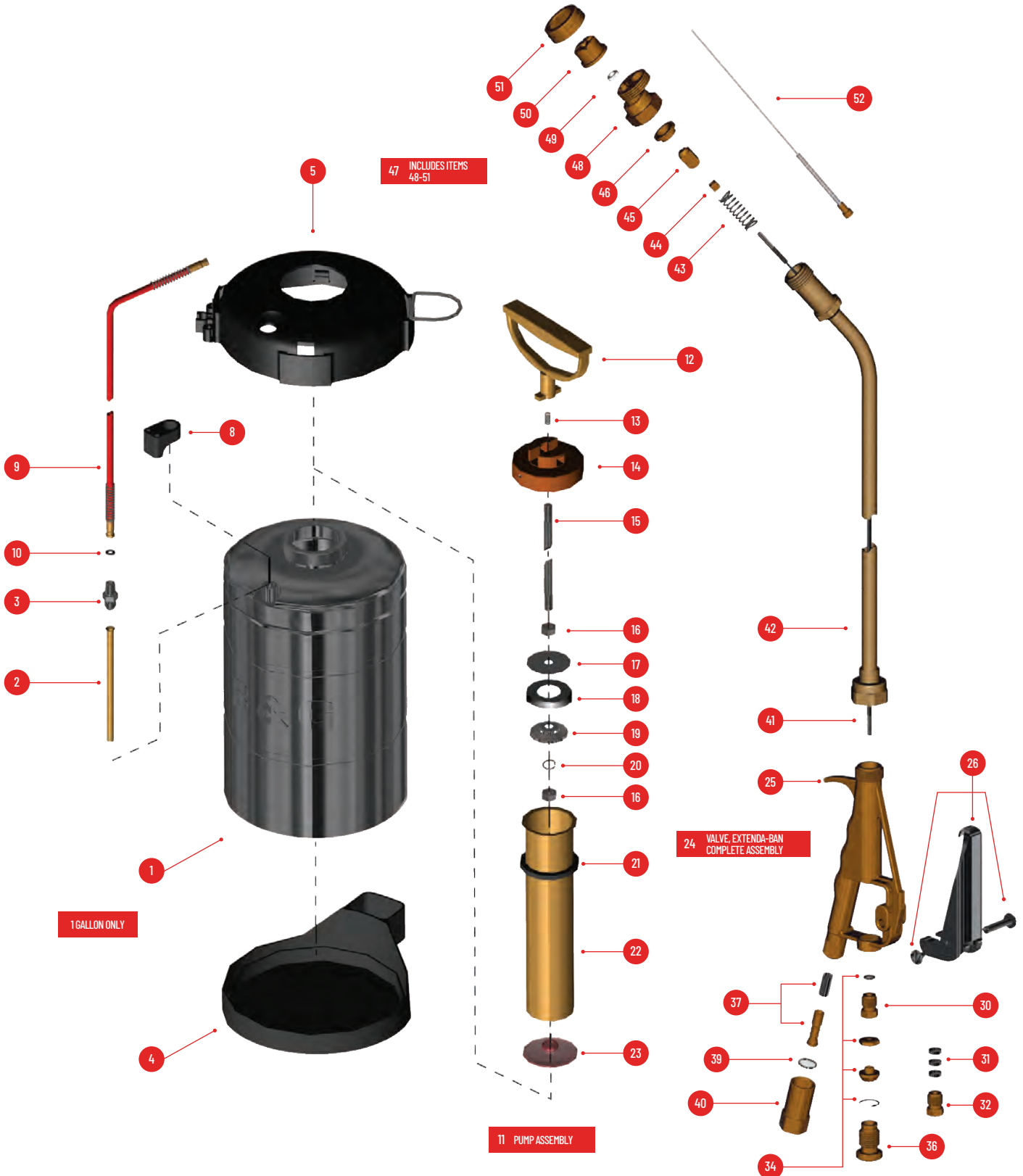

ITEM #	PART #	ORDER #	DESCRIPTION	ITEM #	PART #	ORDER #	DESCRIPTION
1	T-50	22024800	Tank (.5 Gallon)	23	PV-266	22027200	Valve, Check
	T-100	22025000	Tank (1 Gallon)	24	120	22042101	Valve, Extenda-Ban 9" (less tip)
	T-200	22025100	Tank (2 Gallon)		220	22042203	Valve, Extenda-Ban 18" (less tip)
	T-300	22025200	Tank (3 Gallon)		420	22042778	Valve, Extenda-Ban 24" (less tip)
	T-500	22025250	Tank (5 Liter)	25	VB-147	22044450	Valve Body Kit
2	HS-297	22025600	Tube, Siphon (.5 Gallon)	26	VT-140	22042800	Trigger, Valve Housing, Screw
	OS-297	22025700	Tube, Siphon (1 Gallon)	28	-	22025150	Stainless siphon tube, pump cylinder
	TS-297	22025800	Tube, Siphon (2 Gallon)	30	PN-150-2	22042455	Nut, Packing
	THS-297-01	22025901	Tube, Siphon (3 Gallon)	30A	PN-150-1	22042454	(1999 - 2000) Nut, Packing
	FS-297	22025950	Tube, Siphon (5 Liter)	31	VP-151	22045099	Packing, Valve
3	HA-298	22025300	Adapter, Hose	32	PN-150	22044900	Nut, Packing (Prior to 1999)
4	TB-1	22049477	Bottom, Tank (1 Gallon Only)	34	AS-148	22044500	Adjusting Screw, Lock nut, Snap ring
5	TT-1	22049476	Top, Tank (1 Gallon Only)	36	SL-162	22046700	Nut, Safety Lock
8	5700-H	22049475	Holder, Tip (Not used with Item 5)	37	MS-145-50	22043800	Strainer, 50 Mesh Support, Strainer
9	D-50	22030100	Hose, 4 ft., red	39	NG-146	22044200	Gasket, Nylon
10	D-51-P	22030400	Washer, Hose	40	SA-143	22043400	Housing, Strainer
11	PH-265	22026900	Pump Assembly (.5 Gallon)	41	VC-152	22045300	Cable, Valve 9"
	PO-265	22027000	Pump Assembly (1 Gallon)		VC-153	22045400	Cable, Valve 18"
	PF-265	22027125	Pump Assembly (2 Gallon and 5 Liter)		VC-163	22045450	Cable, Valve 24"
	PT-265	22027100	Pump Assembly (3 Gallon)	42	VE-154	22045500	Extension, Brass 9"
12	P-275	22029800	Handle, Pump		VE-155	22045600	Extension, Brass 18"
13	P-276	22029900	Spring, Pump Lock		VE-164	22045650	Extension, Brass 24"
14	P-274	22029700	Cap, Pump		VE-154-SS	22045510	Extension, Stainless Steel 9"
15	PH-273	22029400	Rod, Plunger (.5 Gallon)		VE-155-SS	22045610	Extension, Stainless Steel 18"
	PO-273	22029500	Rod, Plunger (1 Gallon)		VE-164-SS	22045710	Extension, Stainless Steel 24"
	PF-273	22029650	Rod, Plunger (2 Gallon and 5 Liter)	43	VS-156	22045700	Spring, Seat Stem
	PT-273	22029600	Rod, Plunger (3 Gallon)	44	SSL-157	22045900	Nut, Seat Stem
16	P-269-SS	22028250	Nut, Plunger	45	SS-158	22046100	Stem, Seat
17	P-272	22029200	Plate, Back	46	SP-159	22046300	Gasket, Soft Seat
18	NP-277	22029000	Cup, Polypropylene	47	5850-CC	22049466	B&G 4 Way C&C Tip Assembly (Parts 48-51)
	NP-271	22028800	Cup, Leather		5850	22049451	Tip Assembly (No C+C)
19	NP-270	22028600	Plate, Cup Spreader	48	9751-M	22049300	Holder, B&G 4 Way C+C Tip
20	P-269A	22028400	Washer, Lock	49	4190	22034700	Gasket, Viton®
21	P-268	22028000	Gasket, Pump	50	5800-CC	22049467	Tip, B&G 4 Way C+C
22	PH-267	22027400	Tube, Pump (.5 Gallon)		5800	22049452	Tip only (No C+C)
	PO-267	22027500	Tube, Pump (1 Gallon)	51	4596	22034500	Retainer, Tip
	PF-267	22027650	Tube, Pump (2 Gallon and 5 Liter)	52	5700-B	22049200	Extension, C+C
22	PT-267	22027600	Tube, Pump (3 Gallon)				

SPRAYER PARTS

NOZZLES



STRAWS AND NEEDLES

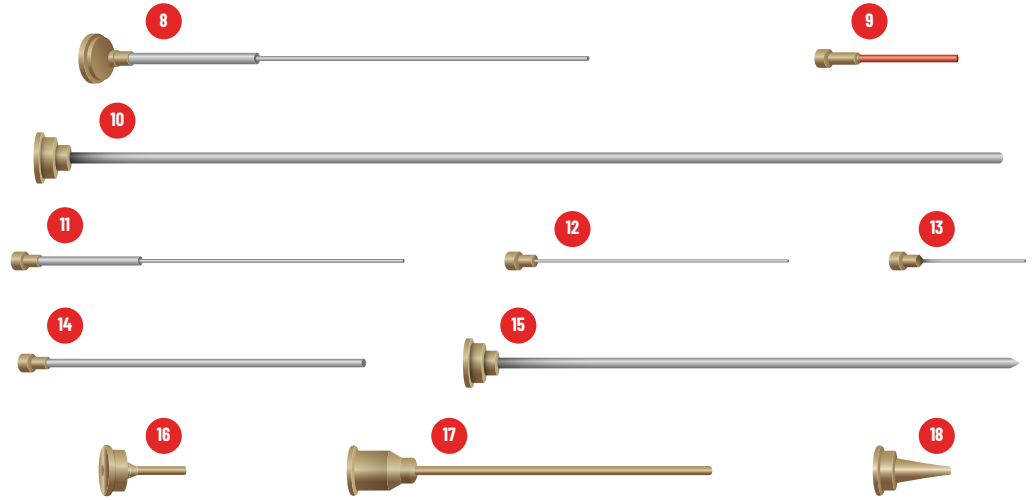

19 TREATMENT VOLUME METER (TVM)

- Attaches to hose and valve
- Measures ounces or ml applied
- Total volume for each account
- Data transferred to smart phone
- Long-lasting battery, 1 hr. charge



20 9" NEXT GEN VALVE WITH BRASS TIP

- Stainless-steel core
- Stainless steel extension
- Brass nozzle
- High-density polymer grip



21 18" NEXT GEN VALVE WITH TIP

- Stainless-steel core
- Stainless steel extension
- Brass nozzle
- High-density polymer grip



SPRAYER PARTS

ITEM #	DESCRIPTION	PART #	ORDER #
Tip Assemblies			
1	B&G 4 Way C+C Tip Assembly (complete)	5850-CC	22049466
2	B&G 4 Way Tip Assembly (complete)	5850	22049451
3	Pin-to-Cone (other sizes available)	5500-Y-2	22036600
4	Adjustable Pin-to-Cone	AV-210	22083602
Nozzles			
5	B&G 4 Way C+C Tip	5800-CC	22049467
6	B&G 4 Way Tip Only (no C+C orifice)	5800	22049452
Straws & Needles			
8	Plastic C+C Straw (fits directly on a gun with a 1325 Tip Cap)	100-CC	22049500
9	1" plastic C+C Straw (fits in B&G 4 Way C+C tip)	1603	22071703
10	Ban-Drip Fan Tip (3/16" dia., 12" long) (requires 1325 Tip Cap)	1052	22039677
11	6" plastic C+C Straw (fits in B&G 4 Way C+C Tip)	5700-B	22049200
12	3.5" Stainless Steel Injector Needle (fits in B&G 4 Way C+C Tip)	5700-SS	22049400
13	2" Stainless Steel Void Tip (fits in B&G 4 Way C+C Tip)	5700-2	22071785
14	4" Stainless Steel 4 Way Void Tip (fits in B&G 4 Way C+C Tip)	5701	22049425
15	8" Mulch/Ant Mound Probe (fits any gun/ext. with 1325 Tip Cap)	100-8	22071684
16	1" Wood Injection Tip (requires 1325 Tip Cap)	Whit-1	22071824
17	4" Wood Injection Tip (requires 1325 Tip Cap)	Whit-4	22071827
18	.5" Wood Injection Tip (requires 1325 Tip Cap)	Wood Tip	24040077
Treatment Volume Meter (TVM)			
19	Treatment Volume Meter (TVM)	-	22046810
Next Gen Valve			
20	9" Next Gen Valve with Brass Tip	-	22042301
21	18" Next Gen Valve With Tip	-	22042401

SPRAYER ACCESSORIES

Take your sprayer to the next level with specialized accessories. Whether you need added mobility, accuracy or power—we have the accessories you’re looking for.

PRESSURIZING TANK TOP (PTT) UPGRADE TO UNSTOPPABLE.

FEATURES

- Attaches to top of B&G tanks
- Maintains 30 psi in tank
- Constant pressure to empty tank
- Long-lasting battery, 4 hr. charge/25-30 gals per charge



PRESSURIZING TANK TOP

ITEM #	DESCRIPTION	MODEL #	ORDER #
1	Pressurizing Tank Top	-	22046000

SPRAYER CADDY

Mounts in service vehicle and holds Primeline sprayers firmly in place. Helps prevent damage or chemical spillage during transportation.

FEATURES

- Heavy duty metal construction
- Chip resistant finish
- Mounting holes for either side or bottom mounting



ITEM #	DESCRIPTION	MODEL #	ORDER #
1	Caddy - 1 gallon and 5 liter - tall	-	11009850
2	Caddy - 2, 3 gallon and 5 liter - short	-	11009860

SPRAYER ACCESSORIES

1 COMFORT GRIP

- Reduce fatigue
- Non-slip grip
- Identify product in the spray tank
- Great for replacements



6 TECHNICIANS EMERGENCY KIT

Commonly needed parts for most B&G equipment. Includes easy to understand drawings of parts, repair hints, and refill quantities. Works in conjunction with the Office Emergency Kit as a refilling station.



4 - 7 FIRST AID KITS

Same as the Gasket Kit but includes higher volumes of all parts. Good for conducting Care & Maintenance classes for an entire office.



7 OFFICE EMERGENCY KIT

Contains more quantities of those parts in the Technician Emergency Kit and also has many less common parts not included in the Technician Emergency Kit. Recommended for office supply rooms. Good for offices with 3 to 8 technicians. Includes easy to understand drawings of parts, repair hints, and refill quantities.

ITEM #	DESCRIPTION	PART #	ORDER #
Comfort Grip			
1	Comfort Grip Handle	GT-100	22029800
Kits			
3	Sprayers with Next Generation Valve	GD-124X	22050101
4	Sprayers with Extenda-Ban Valve and Next Generation Valve	FA-600-D	22050400
5	Sprayers with Ban-Drip Valve	FA-600-B	22050300
6	Technician Emergency Kit	TE-125	23088125
7	Office Emergency Kit	OE-126	23088126

FOGGERS

**UNBEATABLE PERFORMANCE.
UNRIVALED QUALITY.**

Our foggers sit in a class of their own, with user-friendly innovation and unmatched coverage. Proven through constant testing and development, Curtis Dyna-Fog and B&G foggers continue to raise the bar for efficacy in disinfection, pest control and flying insect control.



HURRICANE ES

ELECTROSTATIC EFFICIENCY WITH CONSISTENT COVERAGE.

PORTABLE ELECTROSTATIC AEROSOL APPLICATOR (ULV/MISTER)

ELECTROSTATIC TECHNOLOGY

The Hurricane ES™ utilizes electrostatic technology to charge each droplet to provide effective application of formulations. The droplets stay separated due to the charged nature allowing uniform coverage on the entire target surface.

DISPENSES WATER-BASED PRODUCTS

The Hurricane ES™ is ideal for use in spraying commercial and residential areas. Hotels, schools, greenhouses, warehouses, medical facilities, sanitation, germicidal treatments and disease control programs are markets where the Hurricane ES™ is used.

FEATURES

- Precision flow rate and droplet control
- Uniform and consistent coverage
- Droplet size can be controlled for both ULV and residual spraying
- Stainless-Steel Metering Valve

COMMONLY SPRAYED SOLUTIONS

- Insecticides
- Disinfectants
- Deodorizers
- Fungicides
- Odor Neutralizers
- Water (Humidification)
- Germicides
- Poultry Vaccines

SPECIFICATIONS

ADJUSTABLE FLOW RATES	— 0-6.6 oz/min (3 gal/hr)
DROPLET SIZE	— 10-50 microns (VMD)
DROPLET THROW	— 15 ft
COVERAGE	— 60-80 sq ft
ELECTROSTATIC THRESHOLD DISTANCE	— 12-18 in from the front of the fogger
TANK CAPACITY	— 1 gallon (3.8 liters)
DIMENSIONS	— H 16 in / W 10 in / L 9 in
WEIGHT	— 7.635 lbs (empty)



6-FT ELECTRIC POWER CORD INCLUDED

HIGH CAPACITY CHARGING SYSTEM

PRECISION NOZZLES

- Uniform and consistent coverage
- Three precision nozzles for greater output

ADJUSTABLE TILT LOCKING KNOB

FILL CAP WITH TETHER

STAINLESS STEEL METERING VALVE

- Precision flow rate and droplet control maximizes use of chemicals

1-GAL TANK

- Translucent for easy visual reference
- Corrosion & impact resistant
- Low-profile design virtually eliminates tipping

HURRICANE ES

ITEM #	DESCRIPTION	MODEL #	ORDER #
1	110/120 volt AC, 6.8 Amps, 50/60 Hz	3001-5 Hurricane ES 110V	62150-3
2	220/240 volt AC, 3.4 Amps, 50/60 Hz	3001-6 Hurricane ES 220V	62150-4

HURRICANE ULTRA II

The Hurricane Ultra II is a premier choice for industrial and residential areas—from farms, greenhouses and warehouses to disinfection and disease control programs. Its chemical-resistant precision nozzle and low-profile, sturdy tank make the Hurricane Ultra II both functional and incredibly reliable.

FEATURES

- Rugged design handles corrosive liquids and heavy impacts.
- Dispenses both oil- and water-based formulations
- Solid stainless-steel metering valve for delivering precise outputs and maximizing use of chemicals
- Low profile tank design virtually eliminates tipping...empty or full!
- Droplet sizes can be controlled for both ULV spraying and residual spraying.
- Hurricane Ultra II will replace the Hurricane, Hurricane Ultra, Sanitizer and Anileator. Anileator orifice kit must be purchased separately and installed. Anileator orifice kit part # 62234.

COMMONLY SPRAYED SOLUTIONS

- Insecticides
- Disinfectants
- Deodorizers
- Fungicides
- Odor Neutralizers
- Water (Humidification)
- Germicides
- Poultry Vaccines

PRECISION NOZZLES

- Uniform and consistent coverage
- Three precision nozzles for greater output
- Chemical-resistant for maximum reliability

1-GAL TANK

- Translucent for easy visual reference
- Corrosion & impact resistant
- Low-profile design virtually eliminates tipping

6-FT ELECTRIC POWER CORD INCLUDED

SPECIFICATIONS

ADJUSTABLE FLOW RATES	— 00-6.6 oz/min (3 gallons/hour)
DROPLET SIZE	— 10-50 microns
COVERAGE FOR WATER-BASED APPLICATION	— 60-80 sq ft
TANK CAPACITY	— 1 gallon (3.8 liters)
DIMENSIONS	— H 16 in / W 10 in / L 8.5 in
WEIGHT	— 7.630 lbs (Empty)



HURRICANE ULTRA II

ITEM #	DESCRIPTION	MODEL #	ORDER #
1	110/120 volt AC, 6.8 Amps, 50/60 Hz	Hurricane Ultra 2 120V	62150-1
2	220/240 volt AC, 3.4 Amps, 50/60 Hz	Hurricane Ultra 2 240V	62150-2

CYCLONE ULTRA

The Cyclone Ultra has a 2-stage blower and metering valve assures particles under 20 microns regardless of flow rate. Ideal for areas such as hospitals, nursing homes, schools, apartment buildings, restaurants and greenhouses.

The Cyclone Ultra can apply pesticides, deodorants, fungicides, duct sealant, disinfectants and miticides, efficiently and economically. The Cyclone can be used in indoor/outdoor applications requiring 5-20 micron droplets.

FEATURES

- Delivers both water- and oil-based formulations with moderate to high viscosity

MICROTEC™ NOZZLE

- Creates small, consistent droplets
- Apply disinfectant without wiping
- Reliably disinfect heavily trafficked areas

SPECIFICATIONS

- ADJUSTABLE FLOW RATES — 1.4-3.1 oz/min, 0.6-1.5 gal/hr
- DROPLET SIZE — 8-10 microns, droplet throw 8-12 ft (formulations with high viscosity have larger droplets, 20-24 microns)
- BLOWER — Continuous duty, 200,000 rpm with replaceable brushes
- TANK SIZE — 1-gal tank
- WEIGHT — 9.3 lbs (empty)

6-FT ELECTRIC POWER CORD INCLUDED



METERING VALVE

- Allows for easy control of output and droplet size

1-GAL TANK

- Translucent for easy visual reference
- Corrosion & impact resistant

CYCLONE ULTRA

ITEM #	DESCRIPTION	MODEL #	ORDER #
1	Cyclone Ultra 110 Volt	2734	62250-1
2	Cyclone Ultra 220 Volt	2736	62250-2

TORNADO, TORNADO FLEX

The multi-range Tornado has a 3 gallon tank for extended use, large formulation filter with removable screen and a precision metering valve that allows outputs from a mist of 5 gallons per hour down to ULV range. Ideal for humidification control in greenhouses and application of germicides and disinfectants. These foggers can be used to apply pesticides, deodorants, fungicides, disinfectants, and duct sealant. Treatment sites include hospitals, schools, resorts, food processing plants, warehouses, and dairy, poultry, and horse facilities.

FEATURES

- Delivers both water- and oil-based disinfectant formulations with moderate to high viscosity
- Precision metering valve
- Outputs from a mist of 5 gal/hr down to ULV range

SPECIFICATIONS

INPUT POWER	110/120 V AC, 8.5 amps, 50/60 Hz; 210/250 V AC, 4.2 amps, 50/60 Hz (model 3004)
ADJUSTABLE FLOW RATES	2.4-11.4 oz/min, 1.1-5.3 gal/hr
FLOW RATE	0-18.5 LPH
DROPLET SIZE	5-40 microns
TANK CAPACITY	3 gallon (11.4 liters)
WEIGHT	Tornado: 18.8 lbs (empty) Tornado Flex: 20 lbs (empty)

TORNADO FLEX

- 18-in flexible hose for directional application and precision



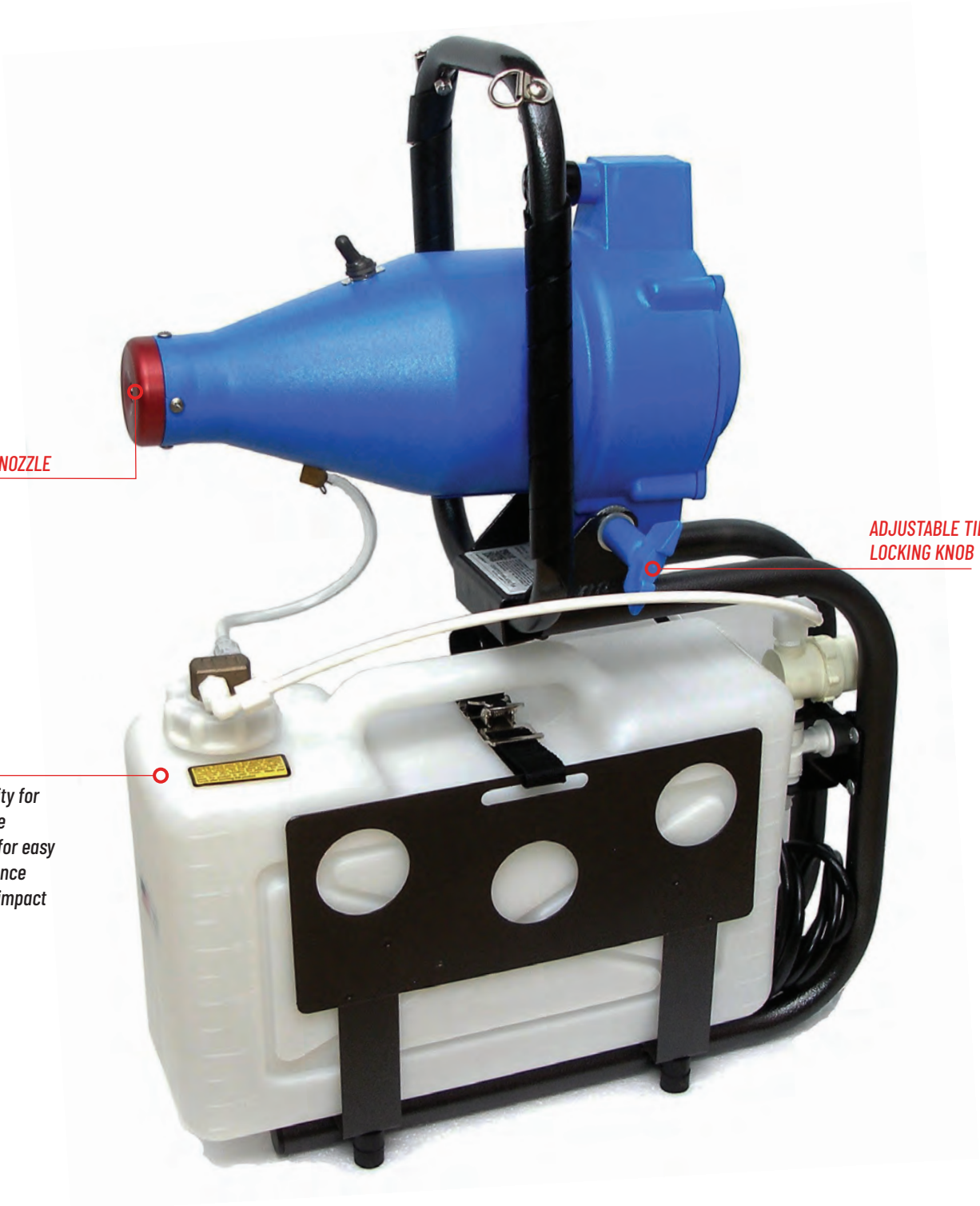

PRECISION NOZZLE

**ADJUSTABLE TILT
LOCKING KNOB**

3-GAL TANK

- Large capacity for extended use
- Translucent for easy visual reference
- Corrosion & impact resistant

TORNADO, TORNADO FLEX

ITEM #	DESCRIPTION	MODEL #	ORDER #
1	Tornado 110 Volt	2895	62380
2	Tornado 220 Volt	2897	62382
3	Tornado Flex 110V	Series 2	63800-2

MY-TI-LITE 2300

FEATURES

- Ideal for general treatment with insecticides and sanitizers
- Flow rate approximately 9 ounces/minute
- Non-adjustable
- Non-ULV



MY-TI-LITE 2300

ITEM #	DESCRIPTION	MODEL #	ORDER #
1	My-Ti-Lite Fogger	2300	15015000

ULTRA-LITE 2400

FEATURES

- Adjustable flow rate up to 2.5 ounces/minute
- Variable delivery from ULV droplets to mist
- Droplets from ULV (20-35 microns) to power mist (56 microns)



ULTRA-LITE 2400

ITEM #	DESCRIPTION	MODEL #	ORDER #
1	Ultra-Lite Fogger	2400	15015100

FLEX-A-LITE 2600

A REPUTATION OF EXCELLENCE.

With its brawny construction and rugged dependability, the Flex-A-Lite 2600 sets the industry standard for heavy-duty point-and-spray foggers. A 1.5-gallon tank and four sturdy feet make it ideal for most industrial, sanitization and janitorial applications. Each fogger is individually built and tested for performance.

SPECIFICATIONS

HOSE	18 in
TANK SIZE	1.5-gal tank
ADJUSTABLE FLOW RATES	0-9.4 oz/min, 0-4.4 gal/hr
DROPLET SIZE	ULV (20-35 microns) to power mist (56 microns), droplet throw 15 ft
COVERAGE	40 sq ft at high application setting
WEIGHT	9 lbs (empty)
DIMENSIONS	H 12 in / W 8.5 in / L 15 in

FEATURES

- Delivers both water- and oil-based formulations with moderate viscosity
- Available with 110V or 220V connections

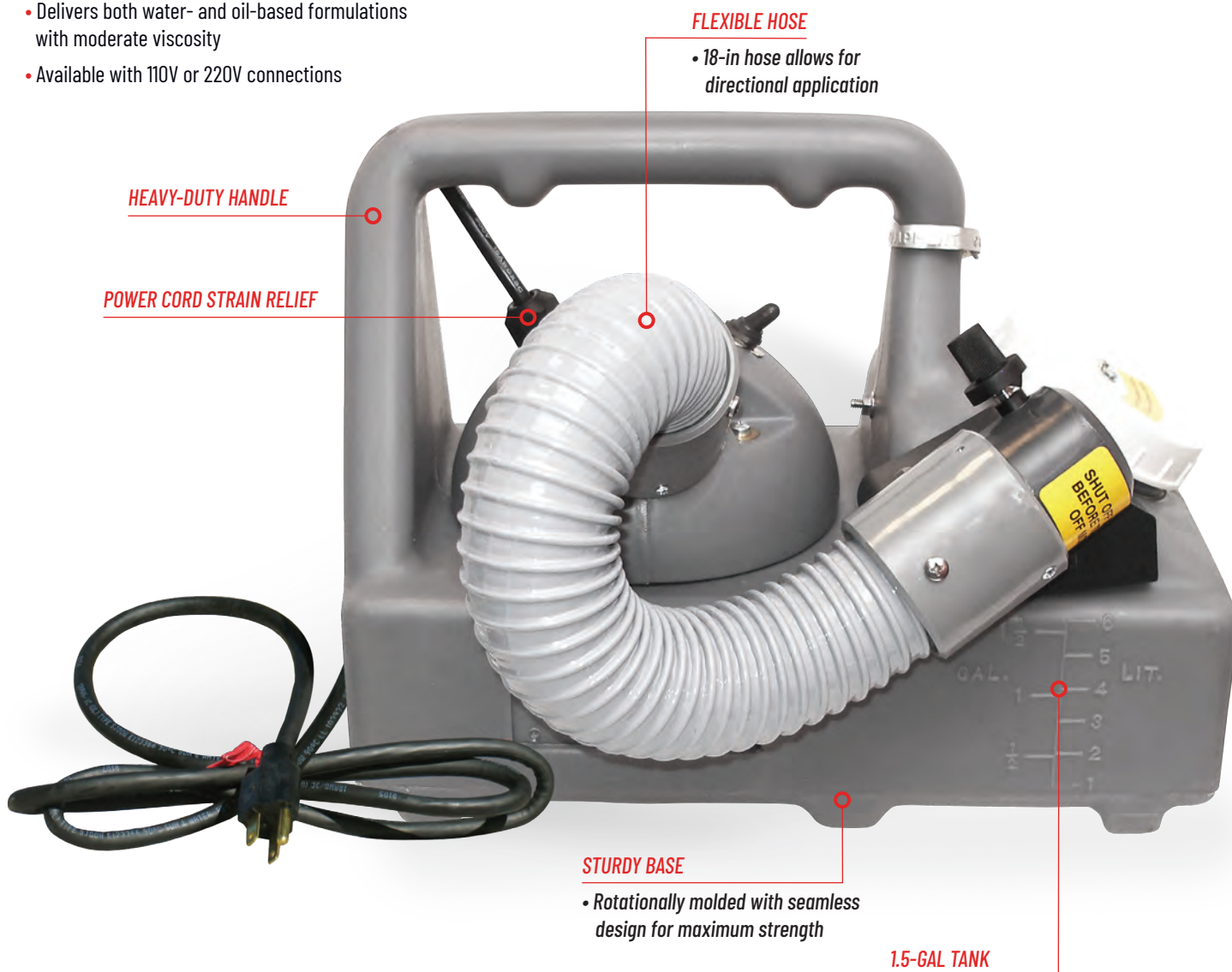

FLEXIBLE HOSE

- 18-in hose allows for directional application

HEAVY-DUTY HANDLE

POWER CORD STRAIN RELIEF

STURDY BASE

- Rotationally molded with seamless design for maximum strength

1.5-GAL TANK

- Marked for easy visual reference
- Corrosion & impact resistant

ULTRA-LITE 2400

ITEM #	DESCRIPTION	MODEL #	ORDER #
1	Flex-A-Lite Fogger	2600	15014901

BACKPACK FOGGERS

Put on a backpack fogger and bring power everywhere you go. Reliable and extremely mobile, our backpacks let applicators accurately disinfect or fog any spot they need.

VERSA-FOGGER

The Versa-Fogger provides 20-35 micron ULV droplets and 56 micron power mist droplets. Portable and powerful, Versa-Fogger is designed for a wide variety of applications from mosquito control and insect control to disinfection. With mobility, range and precision, this backpack fogger fully covers every target. Its heavy-duty construction, along with a deluxe backpack harness, will give you years of dependable service.

FEATURES

- Delivers both water- and oil-based formulations
- Reliable Honda 4 stroke motor - No need to mix oil with the gas
- Emissions compliant motor
- 1-gallon, pressurized formulation tank
- Adjustable handheld nozzle
- Three stage rotary blower
- Lightweight - less than 26 lbs (empty)
- .67 quart fuel capacity
- 2-year motor warranty (1-year other components)

4-STROKE MOTOR

- Gasoline powered
- Low emissions and high performance
- 0.67 qt fuel capacity
- No need to mix oil with the gas

HEAVY-DUTY ISOLATORS

- Reduce engine vibration

1-GAL PRESSURIZED TANK

- Translucent for easy visual reference

SPECIFICATIONS

ENGINE	Honda 4-stroke
SYSTEM	Gasoline-powered backpack
HOSE	4 ft
TANK SIZE	1-gal tank
WEIGHT	26 lbs (dry weight)
ADJUSTABLE FLOW RATES	1.5-6 oz/min (interchangeable nozzles)
DROPLET SIZE	33-44 microns (oil-based formulations provide 20 micron droplets), effective droplet throw 10-12 ft
DIMENSIONS	H 22.5 in / W 12 in / L 14.7 in
SHIPPING DATA	H 16 in / W 19 in / L 26 in; 36 lbs; 4.39 cu ft

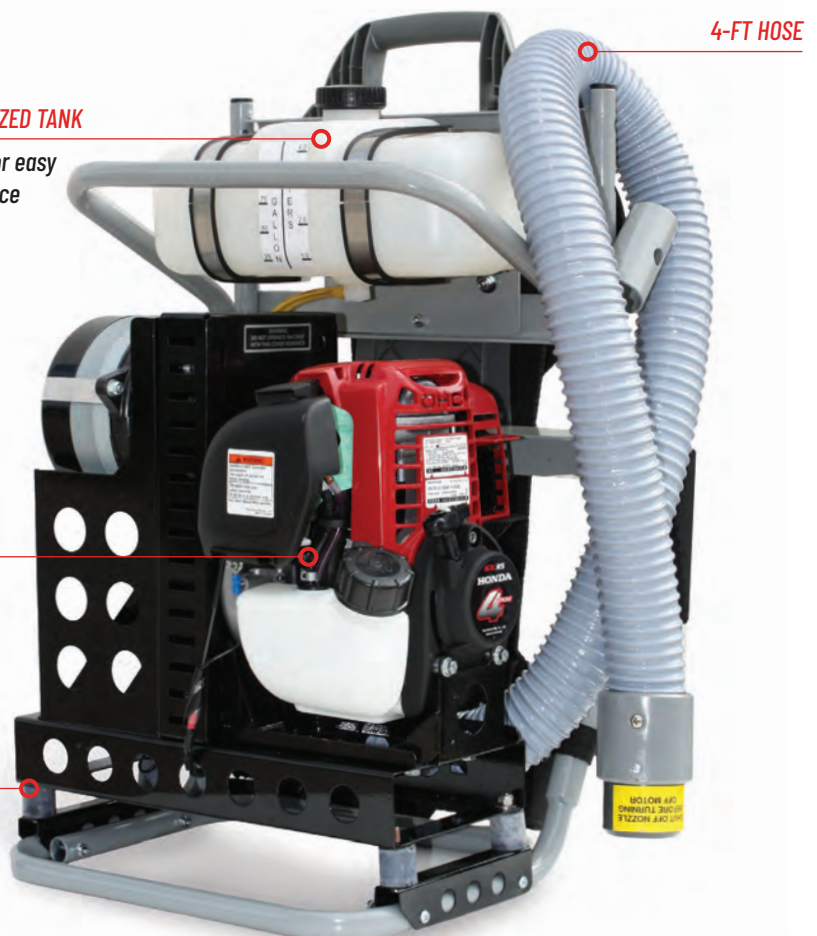

ULTRA-LITE 2400

ITEM #	DESCRIPTION	MODEL #	ORDER #
1	Versa-Fogger	-	4500000

BACKPACK FOGGERS

TWISTER XL3

COMPACT DESIGN WITH POWER ABOVE ITS WEIGHT CLASS.

MOTORIZED KNAPSACK ULV SPRAYER

When you have a lot of ground to cover, you want the most advanced and sophisticated backpack fogger on the market. The Twister XL3 features a remarkable nozzle and blower system that outperforms competitors in value, durability and performance in open-air spaces like stadiums and amphitheaters. Compact, lightweight and designed to minimize engine vibrations, the Twister XL3 is ergonomically suited for extended use.

FEATURES

- Delivers both water- and oil-based formulations
- 4-stroke engine with low emissions and high performance
- 1-gallon pressurized formulation tank

SPECIFICATIONS

ENGINE	—————	Honda 4-stroke, operating speed 7,500 rpm
SYSTEM	—————	Gasoline-powered backpack
HOSE	—————	4 ft
TANK SIZE	—————	1-gal tank
WEIGHT	—————	26 lbs (dry weight)
ADJUSTABLE FLOW RATES	———	1.5–6 oz/min (interchangeable nozzles)
DROPLET SIZE	—————	10–34 microns (oil-based formulations provide 10-micron droplets), effective droplet throw 10–12 ft
DIMENSIONS	—————	H 22.5 in / W 12 in / L 14.7 in
SHIPPING DATA	—————	H 16 in / W 19 in / L 26 in; 36 lbs; 4.39 cu ft

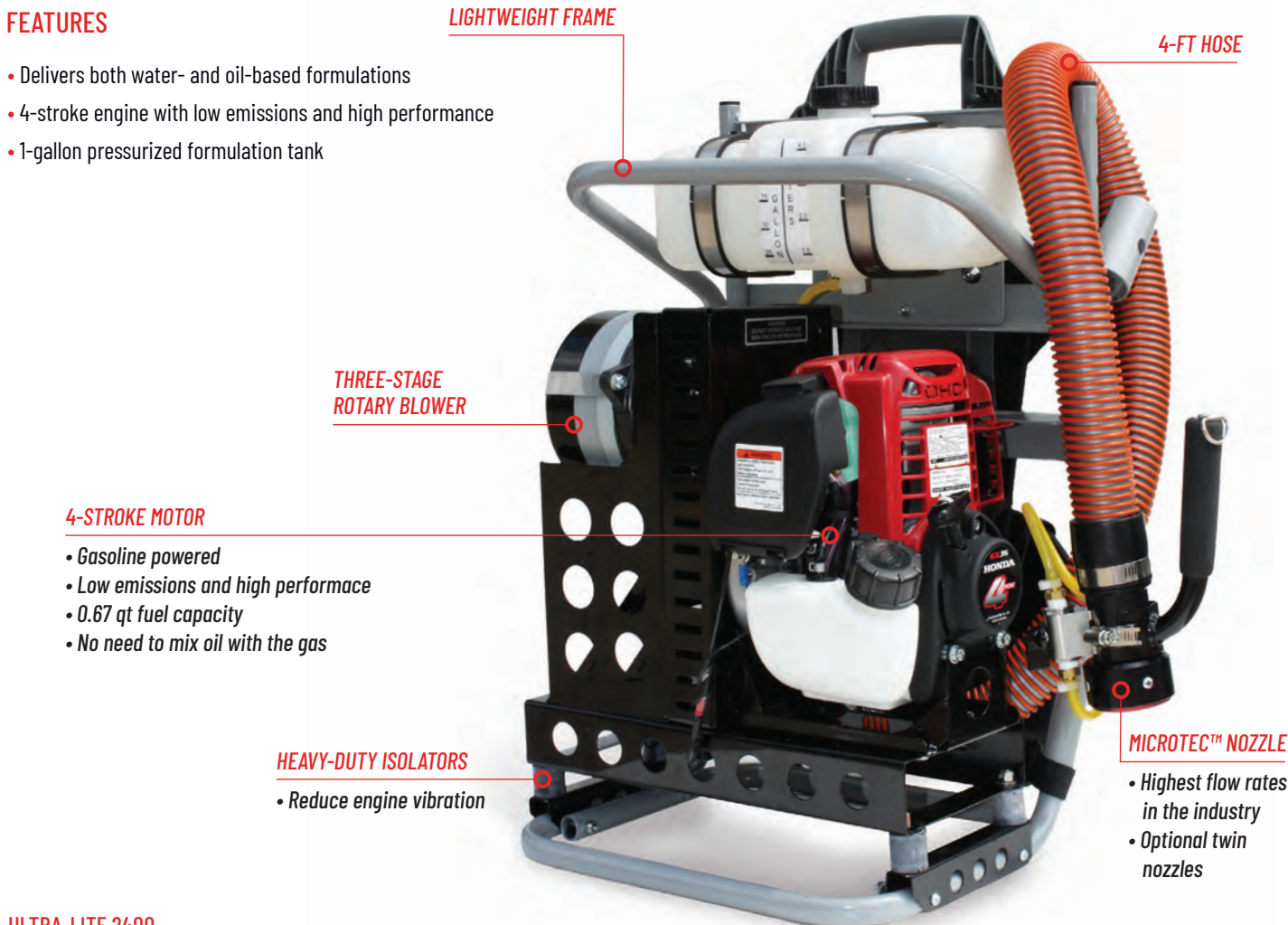

ULTRA-LITE 2400

ITEM #	DESCRIPTION	MODEL #	ORDER #
1	Twister XL3	-	39750

DUSTERS & DUST APPLICATION

ACCURATE APPLICATION IN ANY SPACE.

Our versatile line of dusters feature products for all dust applications from commercial kitchens to bed bug treatments.



BULB DUSTER

FEATURES

- Excellent for granule or dust applications
- Flexible base on extensions for hard-to-reach areas
- Extra tip extension for hard-to-reach areas
- Extension doubles as siphon tube if needed
- All plastic tips for application around electrical outlets
- Belt clip



BULB DUSTER

ITEM #	DESCRIPTION	MODEL #	ORDER #
1	Bulb Duster	1150	11005810

MINI DUST-R

FEATURES

- Chamber holds 0.5 lb. of dust, 7 oz. of granules
- Consistent delivery of granules
- Tip kit is stored inside the plunger tube



MINI DUST-R

ITEM #	DESCRIPTION	MODEL #	ORDER #
1	Mini Dust-R	1151-M	11005850

HAND DUST-R

FEATURES

- Chamber holds 2 quarts of dust
- Extension adds a static charge to the dust
- Ideal for treating attics and crawl spaces
- Includes 12 inch extension with 90° off-set at end of the tube
- Variety of tips included



HAND DUST-R

ITEM #	DESCRIPTION	MODEL #	ORDER #
1	Hand Dust-R	1152-A	11005800

LONG REACH GRANULAR DUST-R

FEATURES

- Chamber holds 2 quarts of dust
- Ideal for treating attics and crawl spaces
- Great for treating wasp nests
- 3-14 inch extensions
- Extension adds a static charge to the dust

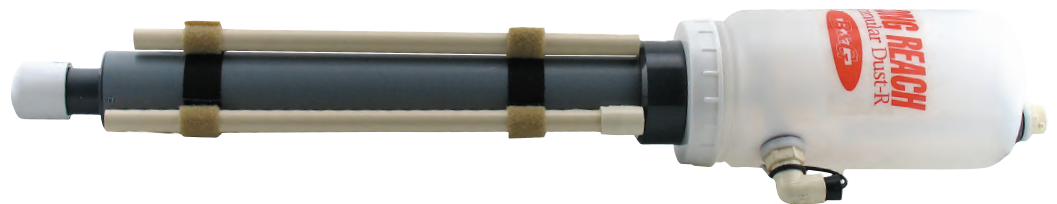

LONG REACH GRANULAR DUST-R

ITEM #	DESCRIPTION	MODEL #	ORDER #
1	Long Reach Granular Dust-R	1153-G	24050000

ELECTRIC DUSTERS

Take on any target without pumping and get dust exactly where you need it.

110V & 220V ELECTRIC DUSTERS

FEATURES

- Chamber holds 3 lbs. of dust or granules
- Extension adds a static charge to the dust
- Flexible 1-foot hose to direct material to target
- Available in 110V or 220V



110V ELECTRIC DUSTER

ITEM #	DESCRIPTION	MODEL #	ORDER #
1	110V Electric Duster	2250	15015605
2	220V Electric Duster	2250/220v	15015610
3	12" Extension	2259	29108459

VERSADUSTER

Great for all dust applications from commercial kitchens to bed bug treatments.

FEATURES

- No batteries required
- XR Valve
- Works with all dust formulations
- Easily plugs into any power source
- "No Clog" design applies a dust application with each pull of the trigger
- Available as a kit (without compressor) for use with a PAS or Versafoamer
- Heavy duty fan cooled compressor unit for long service life. Electrical connection is made by use of a standard extension cord.
- Adjustment knob to control dust output.



VERSADUSTER

ITEM #	DESCRIPTION	MODEL #	ORDER #
1	Versaduster System Complete-110V	-	24010900

DUSTER PARTS/ACCESSORIES

Extra parts for added versatility and upgraded applications. Find the right duster parts for your equipment.

1 TIP KIT

- Can be used as extensions for many of our dust and granular products
- All plastic construction



2 VERSADUSTER TIP KIT



3 VERSADUSTER KIT

Now use a PAS or Versafoamer as a power duster. Comes as a complete kit and simply plugs in. Great for commercial kitchens or bed bug treatments.



4 SPARE BOTTLES AND TIPS

The Versaduster comes with a large and small dust bottle and a variety of tips.



ITEM#	DESCRIPTION	PART #	ORDER #
1	Tip Kit	DB-KIT	11005811
2	Versaduster Tip Kit	-	24010904
3	Kit (no compressor)–Use with PAS or Versafoamer	-	2401901
4	Spare Bottles and Kits	-	24011902

BAIT GUNS

THE RIGHT AMOUNT OF BAIT WITH PINPOINT PRECISION.

B&G bait guns are adjustable to release precise amounts of bait without spilling excess liquid. With durable construction and accessories for efficient unloading, B&G bait guns will stay in your arsenal for years to come.



MULTI-DOSE BAIT GUN

FEATURES

- Consistent delivery with each trigger pull
- Works with most baits
- Range of bait placement sizes available from calibrated knob
- Precision application of gel baits for cockroach and ant control
- Prevents over application, saving you money
- Deluxe bait holster available



MULTI-DOSE BAIT GUN

ITEM #	DESCRIPTION	MODEL #	ORDER #
1	Multi-Dose Gun Kit-Includes gun, extra syringe and syringe tip	3000	24020001
2	Multi-Dose Basic Kit- Gun with no accessories	3000-B	24020002
3	Multi-Dose Gun Deluxe Kit-includes model 3000 and holster	3000-DL	24020000

BAIT GUN ACCESSORIES

1 BAIT GUN HOLSTER

- Removable tube in holster keeps holster clean from accidental bait drips
- Pocket in front for needles and tips
- Straps on each side for extra bait tubes
- Velcro belt strap
- Heavy duty military grade nylon



2 REPLACEMENT TUBES (5)



ITEM #	DESCRIPTION	MODEL #	ORDER #
1	Bait Gun Holster	-	24020040
2	Replacement Tubes (5)	-	24020041

FOAMING EQUIPMENT

THOROUGH COVERAGE IN ALL THE RIGHT SPOTS.

Adding foam applicators to your operation ensures complete coverage to rid spaces of termites and other unwanted pests. Perfect for commercial accounts, B&G foaming equipment is portable and includes a durable case.



VERSAFOAMER HH

FEATURES

- Hand-pump to pressurize and make foam
- Great for wall voids and drains
- Excellent for termites, ants or small flies
- No adjustments, makes great foam every time
- Most parts interchangeable with standard B&G parts



OPTIONAL TIPS

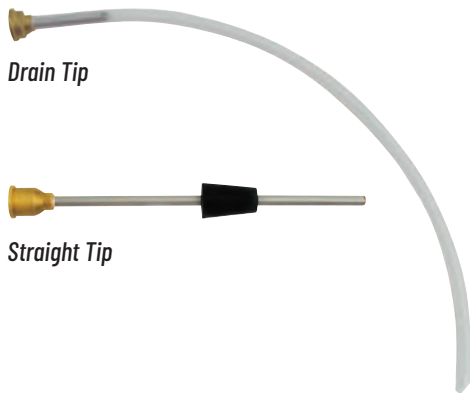

Drain Tip

Straight Tip

VERSAFOAMER HH

ITEM #	DESCRIPTION	MODEL #	ORDER #
1	Versafoamer HH	HH	11007360
2	Repair Kit	GT-100	22049600
3	Optional Drain Tip	-	16200023
4	Optional Straight Tip	-	16200018
5	Curved Tip (included with unit)	-	16200013

VERSAFOAMER 4000

The B&G Versafoamer 4000 is an easy-to-use power foamer and can be used in a wide variety of foaming applications. It's made of heavy-duty components and designed for years of dependable service.

FEATURES

- Electric, compressed-air system
- 1-gallon tank with pressure gauge
- Contained in leak-proof case
- No adjustments, great foam every time
- Quiet compressor motor, 7-foot hose



ULV PORTABLE AEROSOL SPRAYER VERSAFOAMER COMBO UNIT

Combine a PAS with a Versafoamer 4000 to create a flexible pest control system. Use one case and compressor and easily change out tank and valve for each different application.



ITEM #	DESCRIPTION	MODEL #	ORDER #
1	Versafoamer 4000	-	16201003
2	Versafoamer 220v	-	16201002
3	Commercial PAS-9" Extension with Versafoamer 4000	-	16500009
4	Commercial PAS-18" Extension with Versafoamer 4000	-	16500018
5	Standard PAS-9" Extension with Versafoamer 4000	-	16600009
5	Standard PAS-18" Extension with Versafoamer 4000	-	16600018

TERMITE CONTROL

BIG TIME TERMITE TREATMENT.

When it comes to termites, efficiency is everything. That's why B&G Termite Control products are designed for more volume and more tank capacity than typical foamers.



WOOD TREATMENT SYSTEM (WTS)

The B&G Wood Treatment System produces 10-15 times the volume of liquid as compared to a traditional foamer and 5 times more capacity as compared to typical fan sprays.

FEATURES

- Delivers liquid or foam insecticide
- 3-gallon tank, 30-foot or 50-foot hose
- Compressor maintains tank pressure, adjustable to 50 psi
- Ideal for pre-treatments of structural wood, sub-slab re-treatments for termites
- 220V Models available. Contact B&G for more information



WOOD TREATMENT SYSTEM (WTS)

ITEM #	DESCRIPTION	MODEL #	ORDER #
1	WTS-Standard 30' of hose, single surface tip and wall void tip	-	24040000
2	WTS-Deluxe 50' hose, cart handle extender, single 6" surface tip, wall void tip, dual 10" surface tip, and pressure injection tip	-	24040001

TERMITE CONTROL PARTS

Get tips, valves, pipes and more parts to make your termite control equipment unstoppable.

SERIES 400 TERMITE TOOL MODELS

Termite Tool Models are based on the valve (Versagun, Versatool, or Robco) and on the no-drip feature. A check-valve at the end of the 7/16 rods provides no-drip. These Models are 415, 425, and 435. The 410, 420, and 430 Models do not have the check valve. All Models come with a valve, a set of three stainless steel pipes (one .625 inch, and two .4375 inch), a Foot Ram for the .4375 inch diameter pipe, and a Tip Kit (4 tips).

- 4 precision delivery tips included
- Quick-change adapters on all pipes
- Meet current labeling requirements of termiticides
- Tip shut-off available on models 415, 425, 435

1 - 3 VERSAGUN

- Light-weight aluminum
- Balanced trigger for less operator fatigue



4 - 6 ROBCO QCG

- Pressure gauge port at valve
- Converts to a perimeter spray gun



7 - 10 VERSATOOL

- Economical and durable



11 - 13 PIPES

- All soil and sub-slab pipes are stainless steel
- Variety of lengths for all applications
- Comes complete with foot ram assembly

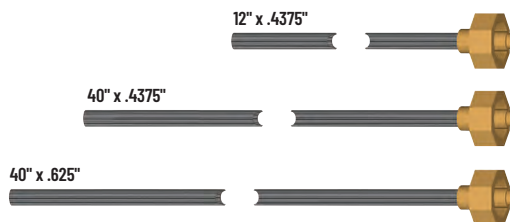

TIPS (included with each Termite Tool Model)

- Two sub-slab tips, one straight tip, and one soil tip for .625 inch pipe
- Stainless steel construction
- Nozzle flow rate calibrated at 20 psi



14



15



16



17

ITEM#	DESCRIPTION	MODEL #	ORDER #
Tip Assemblies			
1	Versagun Model: pipes and Tip Kit, no tip shut-off	430	11007430
2	Versagun Model: pipes and Tip Kit with tip shut-off	435	11007435
3	Versagun valve only		11007406
4	Robco Model: pipes and Tip Kit, no tip shut-off	420	11007420
5	Robco Model: pipes and Tip Kit with tip shut-off	425	11007425
6	Robco valve only		22067700
7	Versatool Model: pipes and Tip Kit, no tip shut-off	410	11007410
8	Versatool Model: pipes and Tip Kit with tip shut-off	415	11007415
9	Slab Injector: .625 dia. 40 in. pipe, foot plate, no tip shut-off	484	11007375
10	Versatool valve only		11007407

Pipes			
11	12" x .4375"	-	22071427
12	40" x .4375"	-	22071428
13	40" x .625"	-	22071429

Termite Tips			
14	360° - .4375" pipe	451	11007451
15	180° - .4375" pipe	453	11007453
16	Void Tip - .4375" pipe	457	11007457
17	360° - .625" pipe	454	11007454

TERMITE CONTROL PARTS

1 - 4 OPTIONAL TERMITE TOOL TIPS AND EXTENDA-PIPES

- Fits All Series 400 Termite Tools



.4375" x 40" Model # 460



.625" x 40" Model # 465

SUB-SLAB INJECTORS AND SOIL RODDING TOOLS

Sub-slab injectors are for application beneath concrete floor to reach the void below, or to treat through tile or wood flooring to reach a void or space beneath the concrete floor. The injection hole through the substrate is sealed with an expandable rubber gasket. Each Injector Kit has two directional tips (180 and 360 degrees). The tips have 2 gallon / minute flow rate and check valve provides tip shut-off. The Sub-Slab injector #6 is 28 in high and ideal for treating in narrow spaces, the Sub-Slab injector #7 is 18 in high.



Included with
SSI- and SSI-14

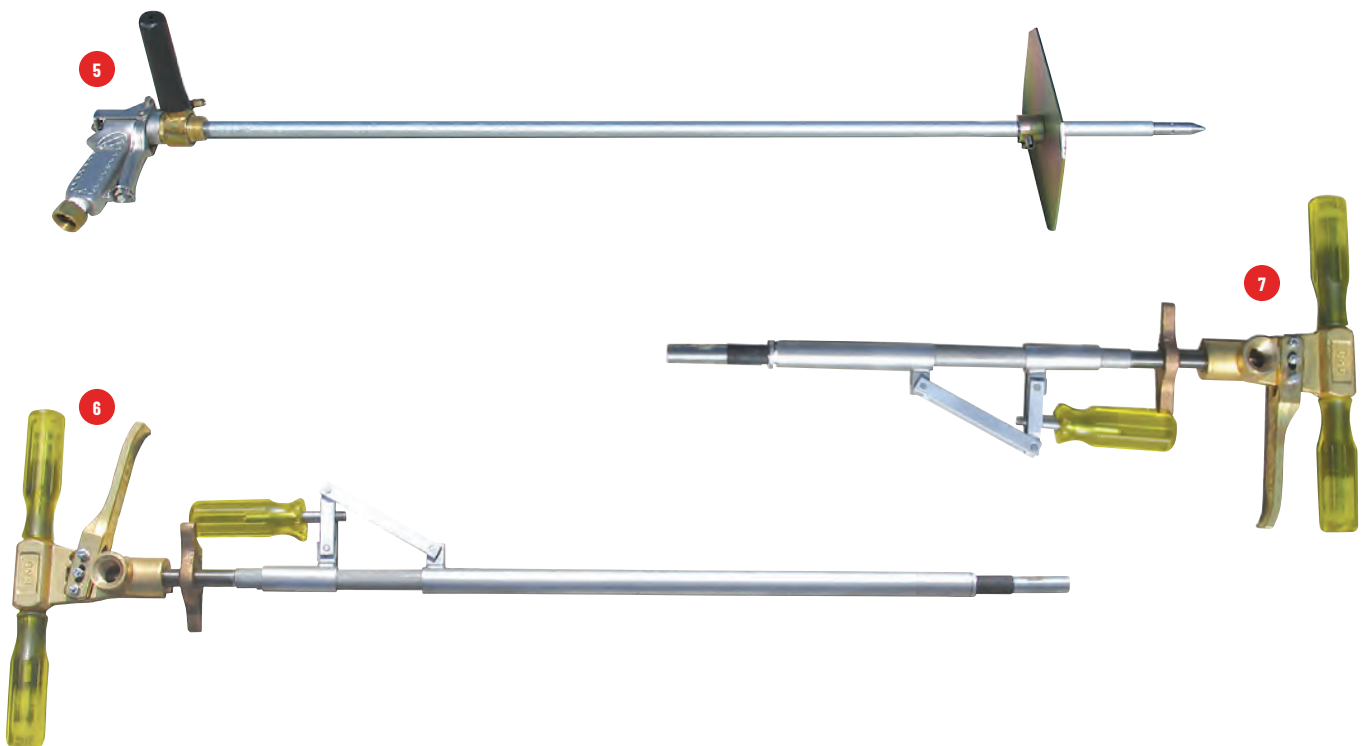

TERMITE CONTROL PARTS

TREBOR® TRIPLE SEAL

The most effective and easiest plug to install for termiticide applications. A hollow core and three flexible lips allow this patented plug to conform to hole irregularities better than solid core plugs. Available in three sizes. Hole size clearly marked on top to eliminate errors.

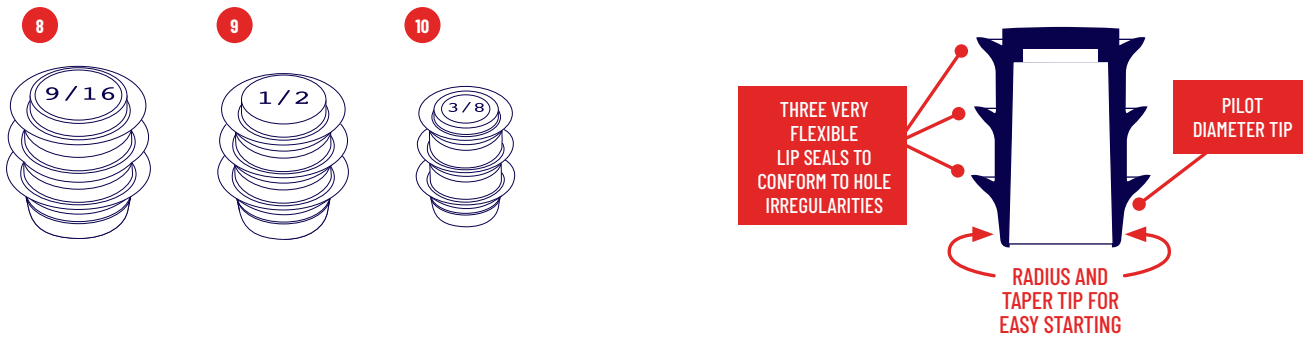

ITEM#	DESCRIPTION	PART #	ORDER #
Optional Termite Tool Tips and Extenda-Pipes (Fits All Series 400 Termite Tools)			
1	360 degree Tip	450	11007450
2	180 degree Tip	452	11007452
3	.625" x 40" Pipe	465	11007465
4	.4375" x 40" Pipe	460	11007460
Sub-Slab Injectors and Rodding Tools			
5	Robco Soil Rodding Tool .625" 360 delivery tip, 40 in. pipe, foot plate	-	22067703
6	Sub-Slab Injector SSI-14 28 in. high	-	11005985
7	Sub-Slab Injector - SSI-4 14 in. high	-	11005965
Trebor® Triple Seal			
8	.5625 Seal - 1 case (10 Buckets of 250 Seals)	4-562-505	45000562
9	.5 Seal - 1 case (10 Buckets of 250 Seals)	4-500-504	45000500
10	.375 Seal - 1 case (10 Buckets of 250 Seals)	4-375-504	45000375

FLY LIGHTS

KEEP FLIES OUT OF SIGHT.

Our complete line of fly lights feature leading patented innovation and beautiful design for unbeatable performance. With proven, industry-tested efficacy, you can select from specialist, glue board, decorative and electric grid fly lights to achieve maximum performance in any environment.



GLUE BOARD FLY LIGHTS

Glue board fly lights use UV light to attract flying insects to the unit, then use a glue board to retain the flying insects. As the insect is caught and retained whole, glue board fly lights are ideal for more sensitive environments. Glue board fly lights are ideal for use in commercial front-of-house areas, commercial kitchens and industrial food preparation zones.

INFINITI™ GAME CHANGING FLY LIGHT TECHNOLOGY.

Designed around the UV LED source, Infiniti™ delivers game changing unique fly light technology to the professional flying insect control market. Infiniti™ differentiates itself from other glue board fly lights by utilizing a unique patented* glue board and patented* UV source to deliver superb efficacy. Fly catch trials have shown that Infiniti™ offers comparable catch results to a traditional 45W UV fly light which uses fluorescent lamps while offering 65% savings in energy running costs!

Infiniti™ is the ultimate choice for a wide range of commercial applications, with additional benefits including the ultra slim profile and bottom loading glue board which make the unit perfect for areas lacking in wall space. The low energy consumption of the unit benefits the environment by reducing emissions and pollution caused by energy generation. With a stylish and contemporary aesthetic, Infiniti™ incorporates features that make servicing and installation quick and easy. The brushed aluminum plated front guard has magnetic closures integrated into the unit, allowing tool free access. A specially designed Glupac® glue board slides in from the bottom of the unit, and sits directly in front of the UV LEDs, improving accessibility and allowing for a slimmer profile fly light.

The unique position of the UV LED strips behind the glue board* helps to increase the capture rate by reducing the common problem of flying insects flying around the UV source without getting caught. The distinctive LED strips* also have an effective UV output life of 3 years, which reduces servicing time and inventory management. Infiniti™ has been specially engineered with curved glue board runners within the unit to provide rigidity to the glue board, preventing it from bowing and maximizing the efficacy of the glue board.

FEATURES

- Glue board access from the bottom for quick and easy servicing
- Low energy running costs
- Compact model for discretion and space
- Restricted installations
- Quick tool free access gives simple access to consumables for easy maintenance
- High efficacy Pelsis UV LED strips provide a 3-year effective life
- Designed for use with Glupac® glue boards with UV stabilizer
- *patents pending

SPECIFICATIONS

DIMENSIONS	—————	H 14 in / W 3 in / L 19.75 in
UV LED STRIPS	—————	2 x LED8S
GLUE BOARDS	—————	1 x INL288
WEIGHT	—————	8.8 lbs

GLUE BOARD FLY LIGHTS

HIGH EFFICACY PELSIS UV LED STRIPS

- Provide 3-year effective life

COMPACT

- For discretion and space

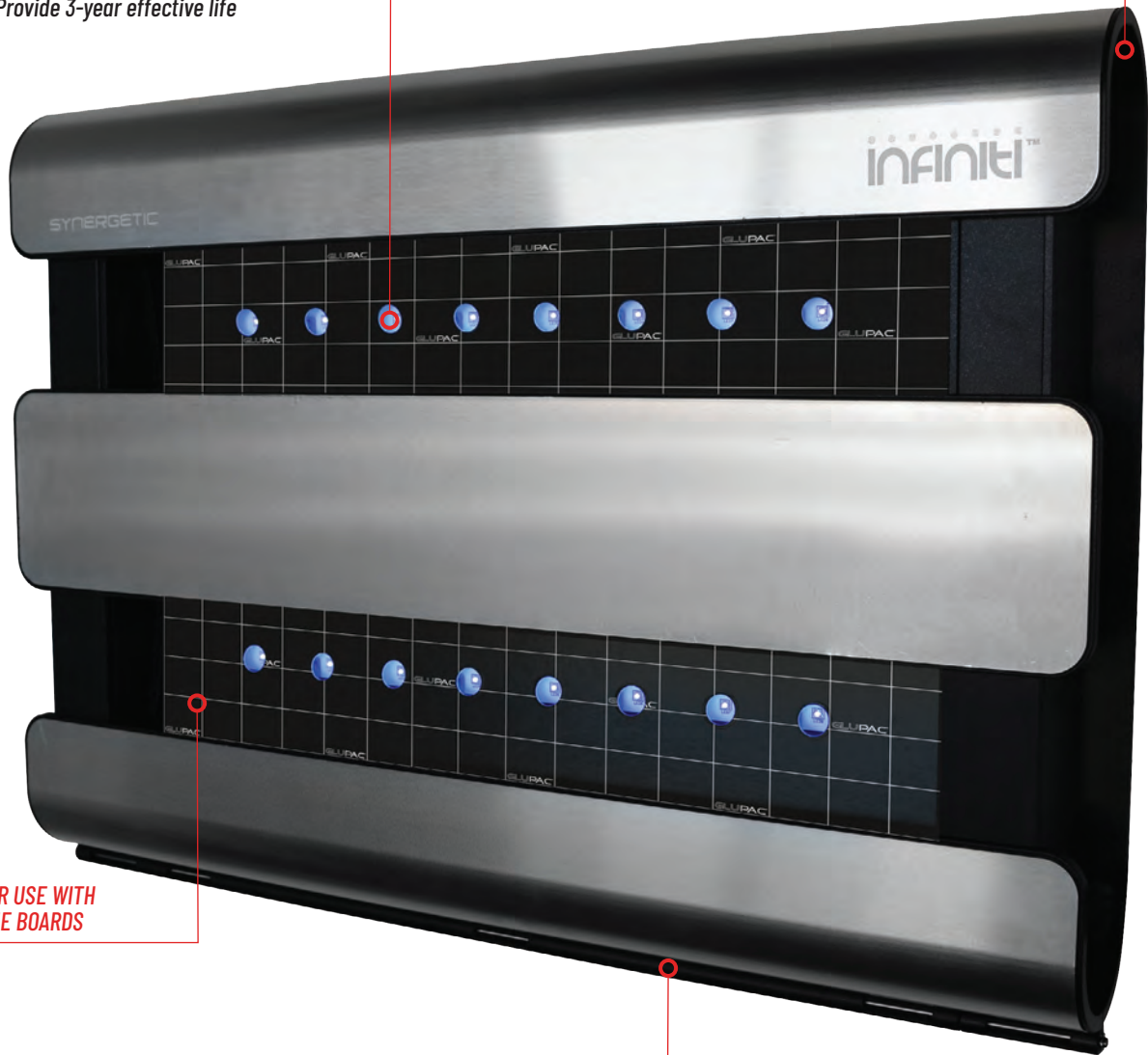

DESIGNED FOR USE WITH
GLUPAC® GLUE BOARDS

QUICK TOOL-FREE ACCESS

INFINITI™

ITEM #	DESCRIPTION	MODEL #	ORDER #
1	Infiniti™	-	INFINITI

GLUE BOARD FLY LIGHTS

HALO CONTEMPORARY STYLE MEETS COMMERCIAL EFFICACY.

With a contemporary, discreet aesthetic and commercial efficacy, the second-generation Halo is the most versatile glue board fly light available for use across a range of commercial applications. Halo is available as a slimline 15, 30 and 45w model, providing a high-quality insect control solution for small or large areas. Offering a wide range of installation options, the second-generation Halo can be vertically or horizontally wall mounted, or desk mounted using the specially designed desk mounting feet. The compact 15w unit can even be discreetly mounted above doors for areas where space is restricted. The Halo is quick and easy to service; the swing down front guard provides complete access to the UV bulbs, while the glue board can be easily changed from either side of the unit. The range uses high efficacy 15w UV bulbs for reduced inventory requirements.

FEATURES

- Commercial efficacy with a contemporary discreet aesthetic for a wide range of applications
- Side access to glue board for quick and easy servicing
- Aluminium removable debris tray
- Closable light apertures for maximum light output or prevention of dust ingress
- Compact 15w model for space restricted installations
- Quick tool free access gives simple access to consumables for easy maintenance
- Unique dual wavelength Synergetic® Technology for an increased catch
- Designed for use with Glupac® glue boards with UV stabilizer
- 28% increase in UV irradiance from first generation (Halo 30 and Halo 45)
- Desk mount feet and feet fixing pins are available for HL15 and HL45
- Application: commercial kitchen, front of house, industrial food preparation areas

SPECIFICATIONS - SLIMLINE 15w

DIMENSIONS	H 10 in / W 4.5 in / L 23 in
COVERAGE	430 sq ft
BULBS	1 x TGX 15-18
GLUE BOARDS	1 x GB015
WEIGHT	10 lbs

SPECIFICATIONS - SLIMLINE 30w

DIMENSIONS	H 16 in / W 4.5 in / L 23 in
COVERAGE	860 sq ft
BULBS	2 x TGX15-18
GLUE BOARDS	1 x GB012/GB002
WEIGHT	12.5 lbs

SPECIFICATIONS - SLIMLINE 45w

DIMENSIONS	H 16 in / W 4.5 in / L 23 in
COVERAGE	1300 sq ft
BULBS	3 x TGX15-18
GLUE BOARDS	1 x GB012/GB002
WEIGHT	14.5 lbs

HALO SLIMLINE 15w

- For space restricted installations



GLUE BOARD FLY LIGHTS



HALO SLIMLINE 30w

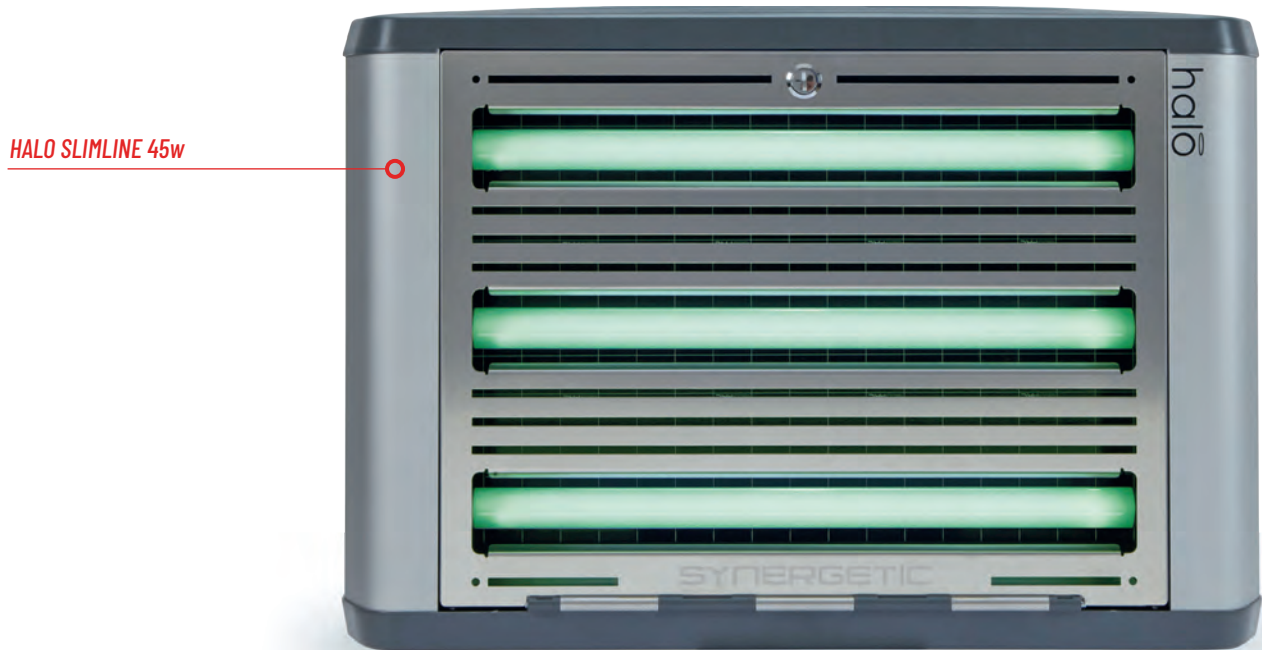

HALO SLIMLINE 45w

HALO

ITEM #	DESCRIPTION	MODEL #	ORDER #
1	Halo 15w (2nd generation)	Halo 15	HL15/110v
2	Halo 30w (2nd generation)	Halo 30	HL30/110v
3	Halo 45w (2nd generation)	Halo 45	HL45/110v

GLUE BOARD FLY LIGHTS

EDGE®

Developed to be the most effective glue board fly light on the market, Edge® is designed around patented (European Patent No. EP2269448B) glue board technology to catch significantly more flying insects than traditional glue boards. As the glue board is inserted into the flylight it self-folds at the desired points, creating a unique form around high efficacy Synergetic® UV bulbs. This unique design forms edges, proven to be more attractive to flies, maximizes useful UV light output, and creates a 30% larger glue area than traditional glue boards, creating a staggering 31.5% increase on a normal catch rate!

The unique glue board form provides three features shown to better catch flying insects:

1. The glue board forms edges, proven to be more attractive to flies
2. 30% larger glue area than traditional 'flat' glue boards
3. The glue area is equidistant from the UV bulbs, maximizing the useful glue

FEATURES

- Desk mount feet and feet fixing pins are available for edge. Please contact Pelsis to find out more.
- Application: commercial kitchen: industrial food preparation, front of house

SPECIFICATIONS

DIMENSIONS	—————	H 14.75 in / W 22.25 in / L 4.25 in
COVERAGE	—————	1300 sq ft
BULBS	—————	2 x TGX15-18
GLUE BOARDS	—————	1 x INF198
WEIGHT	—————	12 lbs



EDGE®

ITEM #	DESCRIPTION	MODEL #	ORDER #
1	Edge® 30watt, Stainless	-	ZF105/110v

GLUE BOARD FLY LIGHTS

FLYTRAP PROFESSIONAL™

Flytrap Professional™ (FTP) provides a professional and hygienic solution to insect control for sensitive areas such as food preparation areas. One of the most effective professional units on the market, Flytrap Professional gives 360° of light output and the simple glue board and bulb replacement makes Flytrap Professional extremely service friendly. Available as a 30w white metal unit and a new 80w stainless steel device, Flytrap Professional can be mounted by seven different methods providing one of the most flexible and versatile professional fly light brands on the market.

FEATURES

- Choice of seven mounting options for maximum versatility
- Simple glue board and bulb replacement
- Provides 360° light output and ease of access for flying insects
- Open design to increase attractant area
- Designed for use with Glupac® glue boards with UV stabilizer
- High efficacy shatterproof UV bulbs
- All metal construction
- Room coverage: 2600 ft²
- Application: industrial food preparation areas

SPECIFICATIONS - 30w WHITE METAL

DIMENSIONS	H 5.5 in / W 12 in / L 18.5 in
COVERAGE	860 sq ft
BULBS	2 x TPX15-18S
GLUE BOARDS	1 x GB001
WEIGHT	8.5 lbs

SPECIFICATIONS - 80w STAINLESS STEEL

DIMENSIONS	H 6.25 in / W 12 in / L 25.25 in
COVERAGE	2600 sq ft
BULBS	2 x TPX36-24S
GLUE BOARDS	1 x GB011
WEIGHT	12.1 lbs

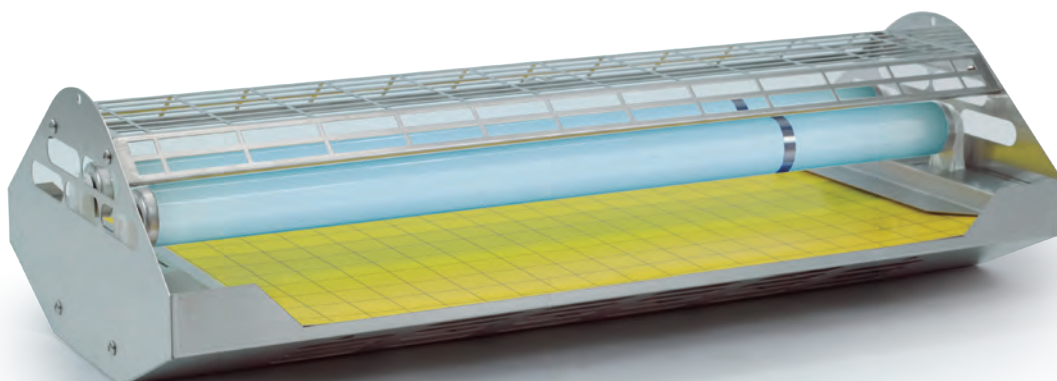

FLYTRAP PROFESSIONAL™

ITEM #	DESCRIPTION	MODEL #	ORDER #
1	Flytrap Professional™ 30w White Metal	FTP30	ZF028/110v
2	Flytrap Professional™ 80w Stainless Steel	FTP80	ZF033/110V

SPECIALTY FLY LIGHTS

Demanding environments can often require specialist flylights to ensure the highest standards in hygiene and safety.

HALO AQUA

Part of the comprehensive Halo range, the Halo 45w Aqua model is suitable for use in harsh environments that may require hosing down. This Halo Aqua model incorporates FEP coated shatterproof bulbs and a robust construction, while maintaining a contemporary design. Offering a variety of installation options, the Halo 45w Aqua can be wall mounted vertically or horizontally. With a swing down front guard, it provides complete access to the UV bulbs and glue board and the quick release lamp holder covers make it extremely quick to service.

FEATURES

- Stainless steel construction
- Commercial efficacy with a contemporary discreet aesthetic for a wide range of applications
- Side access to glue board for quick and easy servicing
- Aluminum removable debris tray
- Unique, quick release lamp holder covers protect against water ingress
- Closable light apertures for maximum light output or prevention of dust ingress
- Quick tool free access gives simple access to consumables for easy maintenance
- High efficacy shatterproof UV bulbs
- Designed for use with Glupac® glue boards with UV stabilizer, made from durable PVC that can withstand hosing down and harsh environments
- Part of a comprehensive range of commercial glue board fly lights (see page 12 for more details)
- Application: commercial kitchen: front of house, industrial preparation areas

SPECIFICATIONS

DIMENSIONS	H 16 in / W 4.5 in / L 23 in
COVERAGE	1300 sq ft
BULBS	3 x TGX15-18S
GLUE BOARDS	1 x GB013 (large)
WEIGHT	14.5 lbs

LAMP HOLDER COVERS

- Protect against water ingress

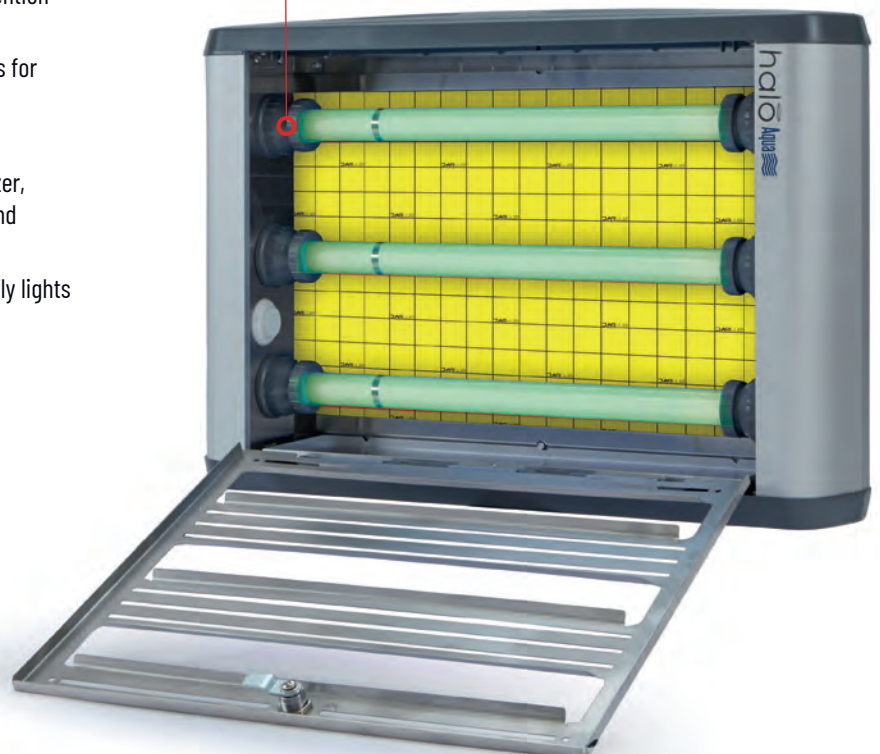

SPECIALTY FLY LIGHTS

HIGH EFFICACY SHATTERPROOF UV BULBS

STAINLESS STEEL CONSTRUCTION

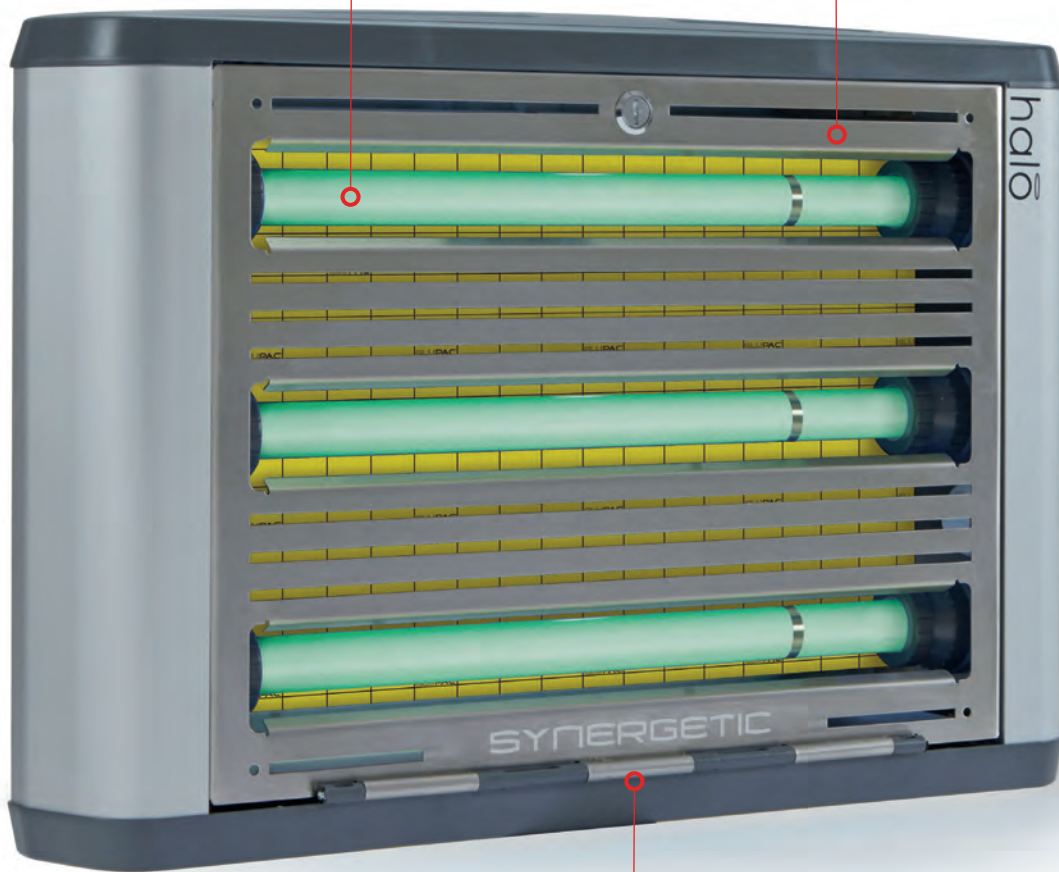

QUICK TOOL-FREE ACCESS

HALO AQUA

ITEM #	DESCRIPTION	MODEL #	ORDER #
1	Halo 45w Aqua	-	HL45IP/110V

DECORATIVE FLY LIGHTS

Designed for use in front-of-house areas, decorative fly lights discreetly protect areas which are highly visible to customers. Insects are attracted by UV light then retained with highly effective glue boards to ensure that flying insects are kept at bay. Decorative units are ideal for use in restaurants, cafes, hotel lobbies, reception areas, food service and dining areas.

HALO CURVE

A beautifully designed, decorative fly light, the Halo Curve is the perfect addition to front-of-house areas. The elegant shaped facade is punctuated by stylish detailing, hiding caught flies from the view of customers in restaurants, hotels, cafes and bars, and finished with cobalt grey UV stable polycarbonate edging. Easy to service, the front guard pivots to allow quick and easy tool free access to the two 15w bulbs and glue board, without the need to remove the guard during servicing.

SPECIFICATIONS

DIMENSIONS	—————	H 10 in / W 4.75 in / L 20.25 in
COVERAGE	—————	650 sq ft
BULBS	—————	2 x TGX15-18
GLUE BOARDS	—————	GB005
WEIGHT	—————	6 lbs

FEATURES

- Elegant detailing and slim decorative design
- Part of the coordinated Halo range
- Ultra-discreet fly catching glue board hidden from view
- Horizontal or vertical mounting
- Quick and simple IEC mains socket, or discreet hard wiring option
- Easy tool free access and efficient servicing
- High efficacy UV bulbs
- Designed for use with Glupac® Glue boards with UV stabilizer
- Application: Front of house

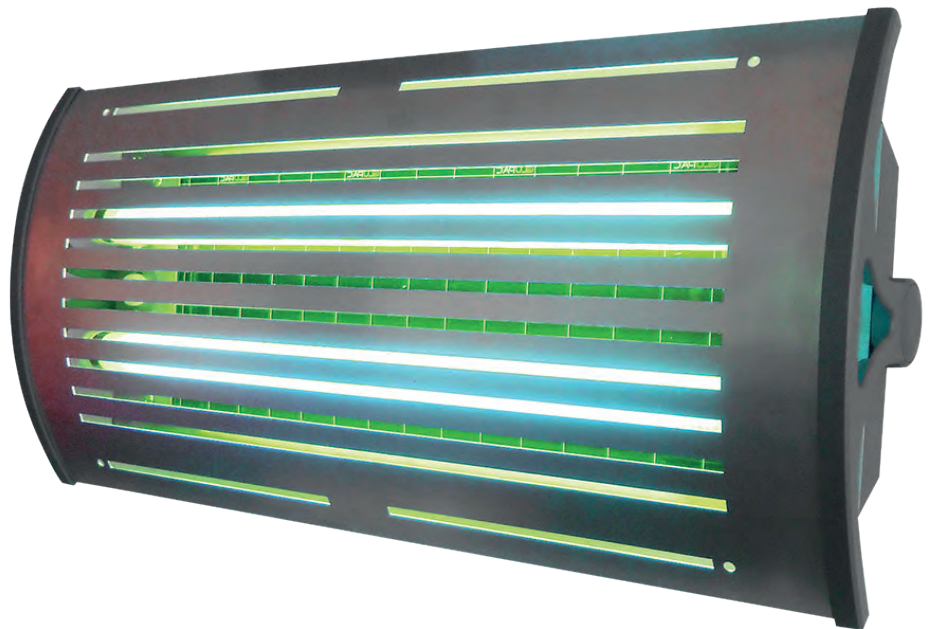

HALO CURVE

ITEM #	DESCRIPTION	MODEL #	ORDER #
1	Halo Curve, 30 watts	-	HLCURVE

DECORATIVE FLY LIGHTS

NECTAR

Nectar offers a highly effective in-counter solution to flying insects, providing versatile installation and simple servicing.

FEATURES

- Simple in counter or wall mounting options
- Unique dual wavelength Synergetic® technology for an increased catch
- Two glue boards positioned close to UV bulb create large catch area
- Two easy to change common glue boards, with grids for simple insect analysis
- Variable shield keeps insects hidden from customer sight and changes the direction of the direct light where required
- Contemporary design includes removable clips for in-counter advertising
- Robust stainless steel and UV stable polycarbonate construction
- Fitted with unique dual wavelength shatterproof
- Application: Full in-counter + food display area

SPECIFICATIONS

DIMENSIONS	H 4.75 in / W 4 in / L 21.5 in
COVERAGE	Full counter coverage
BULBS	1 x TGX15-18S
GLUE BOARDS	2 x INL170
WEIGHT	4.5 lbs

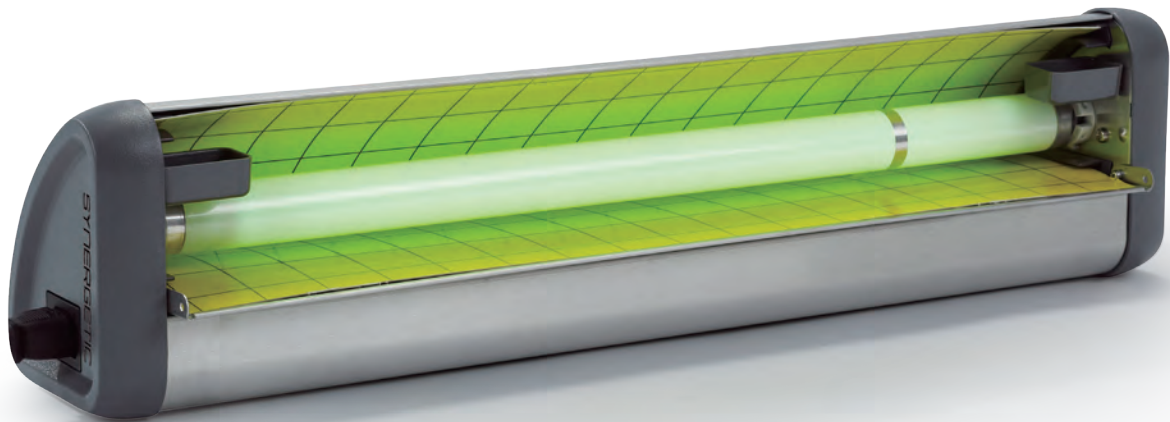

NECTAR

ITEM #	DESCRIPTION	MODEL #	ORDER #
1	Nectar, 15 watts, Stainless	-	ZL055/110V

DECORATIVE FLY LIGHTS

LURALITE PROFESSIONAL

Developed as a highly effective but discreet solution for insect control, Luralite™ fly lights are ideal for use in restaurants, bars, cafes and other front of house applications. Luralite is available in two sizes with the compact Luralite CentoPlus emitting 18 watts of UV light and the larger Luralite Professional, offering a higher light output and a larger glue board for increased efficacy. Both styles are easy to service and are designed for use with genuine Glupac® glue boards, which incorporate UV stable dry glue for longer life and an increased catch.

SPECIFICATIONS

DIMENSIONS	H 7.25 in / W 8.25 in / L 28.25 in
COVERAGE	538 sq ft
BULBS	2 x TPX15-18
GLUE BOARDS	1 x INL121
WEIGHT	10 lbs

FEATURES

- A simplified design increasing performance and reducing service time. By removing the 'reflector top', the new design is proven to emit 44% more UV irradiance, maximizing the attraction of flying insects.
- Application: Front of house

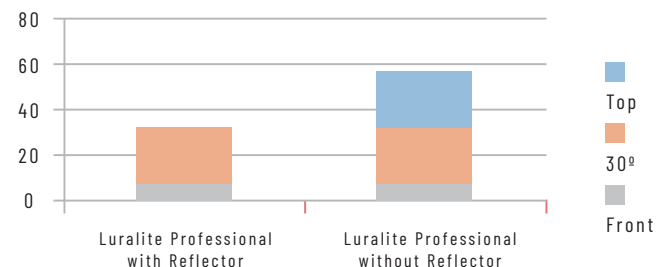
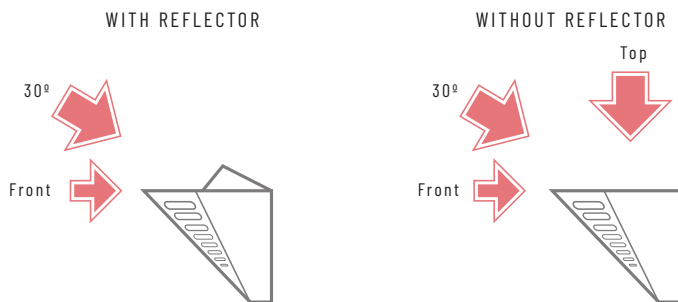
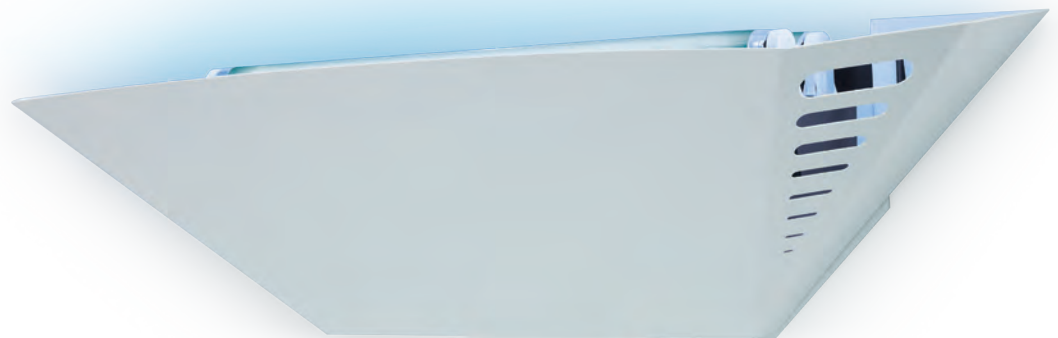

LURALITE PROFESSIONAL

ITEM #	DESCRIPTION	MODEL #	ORDER #
1	Luralite Professional 30watt, White	-	ZL015/110

DECORATIVE FLY LIGHTS

LURALITE CENTOPLUS

FEATURES

- Ideal for front-of-house applications
- Quick and easy glue board and bulb replacement
- High efficacy UV bulbs
- Designed for use with Glupac® glue boards with UV stabilizer
- Robust all metal construction
- Application: Front of house

SPECIFICATIONS

DIMENSIONS	H 7.75 in / W 7 in / L 17.5 in
COVERAGE	270 sq ft
BULBS	1 x TPX18
GLUE BOARDS	1 x INL128
WEIGHT	5.5 lbs

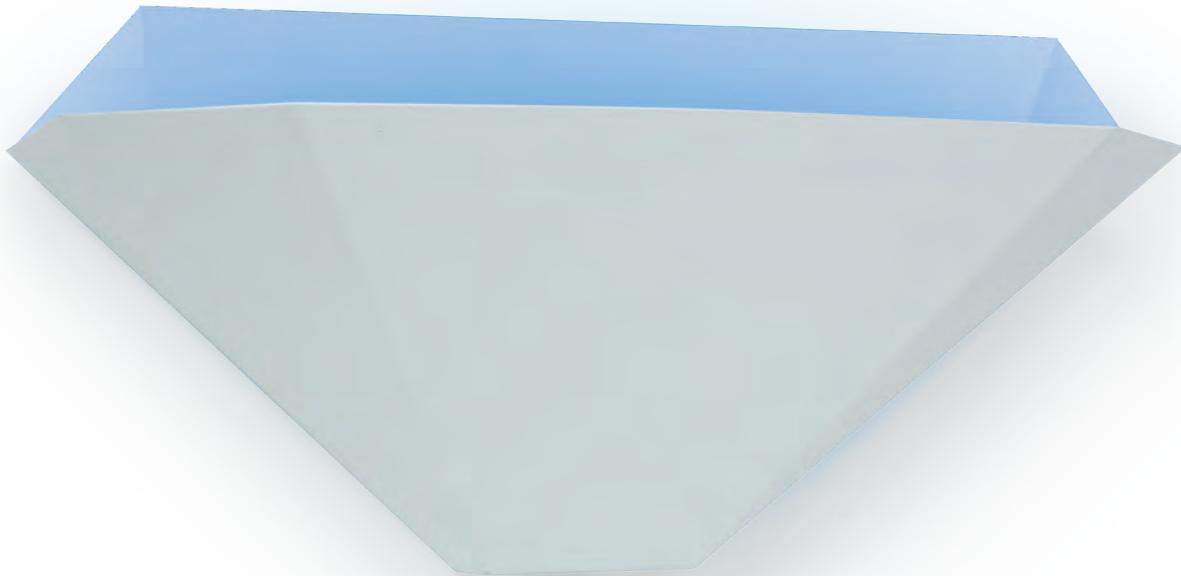

LURALITE CENTOPLUS

ITEM #	DESCRIPTION	MODEL #	ORDER #
1	Luralite Centoplus, 18watt, White	-	ZL009/110v

DECORATIVE FLY LIGHTS

FLYPOD

Flypod® incorporates several unique features to provide commercial effectiveness and domestic serviceability. Designed specifically to be quick and easy to service, Flypod incorporates a patented rear glue board removal system, ensuring the user doesn't come into contact with dead flies or the sticky glue board.

FEATURES

- Patented rear glue board removal provides ease of service for the user
- Unique cone shaped body traps fly inside before catching it on the glue board
- Unique curved base sits flush to the desk top allowing flies to crawl up to the UV light source
- High efficacy UV bulbs
- Designed for use with Glupac® glue boards with UV stabilizer
- The polypropylene diffuser distributes the UV light throughout 180° whilst discreetly hiding caught flies
- With its stylish and compact design, Flypod discreetly fits in with any front of house or domestic environment
- Application: Front of house

SPECIFICATIONS

DIMENSIONS	H 12 in / W 6.75 in / L 7.75 in
COVERAGE	323 sq ft
BULBS	1 x TPX18
GLUE BOARDS	1 X INL252
WEIGHT	3.25 lbs



FLYPOD

ITEM #	DESCRIPTION	MODEL #	ORDER #
1	Flypod, 18 watt	-	ZF050/110v

DECORATIVE FLY LIGHTS

AURA ULTRA DISCREET AND ULTRA STYLISH.

With an attractive, contemporary design, the Aura™ decorative fly light is an ultra-discreet unit ideal for front-of-house applications.

Perfect for use within cafes, restaurants, bars and hotels, the Aura offers an elegant, modern aesthetic alongside innovative, easy-to-service features and maximum efficacy. The unique circular registered design of the unit allows light to attract flying insects from a full 360° around the unit, attracted by the unique Synergetic® green light, while the design of the discreetly positioned glue board gives a 100% useful glue area which remains hidden from customer view.

FEATURES

- Contemporary detailing and elegant clean lines
- Beautifully polished facade
- Slim design ensures that the unit is unobtrusive
- Ultra-discreet fly catching glue board hidden from view
- 100% useful glue board area ensures maximum efficacy
- Ensures compliance with food hygiene legislation
- Unique dual wavelength Synergetic® technology for an increased catch
- Easy tool free access and efficient, fast servicing
- Robust stainless steel and UV stable polycarbonate construction
- Application: Front of house

SPECIFICATIONS

DIMENSIONS ————— H 10.5 in / W 5.25 in / L 10.5 in
 COVERAGE ————— 430 sq ft
 BULBS ————— 1 x TGX22
 GLUE BOARDS ————— 1 x INL198
 WEIGHT ————— 4.25 lbs

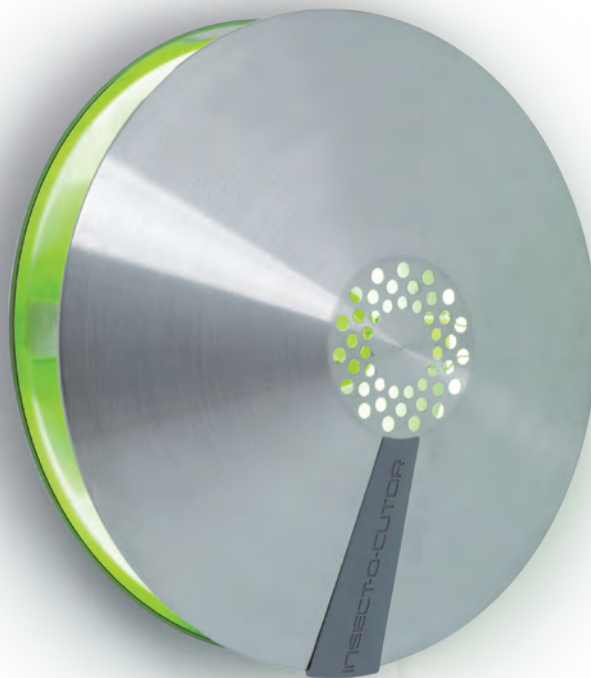

AURA

ITEM #	DESCRIPTION	MODEL #	ORDER #
1	Aura Stainless Steel 22 watt	-	ZL051/110v
1	Aura Black Finish 22 watt	-	ZL051-BLACK

ELECTRIC GRID FLY LIGHTS

Electric grid fly lights use UV light to attract flying insects to the unit, then use an electric grid to kill the insects, before retaining them in a catch tray to allow hygienic disposal. Electric grid fly lights are ideal for use in commercial backroom, commercial front of house and industrial backroom areas.

ALLURE

Proven to have more than 60% greater UV light output than traditional electric fly lights. With an innovative, patented* open top design to maximize light output of the Synergetic® UV bulbs, this truly unique zapper fly light releases light from the back, sides and top of the unit, creating 67% more useful UV light output than traditional fly lights utilizing the same power UV bulbs.

The unique Z-shaped killing grid provides a 20% larger fly killing area, ensuring that the unit easily copes with the increased number of flies attracted by the greater light output. Designed with serviceability in mind, the killing grid, deep catch tray and UV bulbs are easily cleaned and maintained while the tool free, drop down front guard, also holds the catch tray during servicing making the unit quick and easy to service. Independent tests show that the Allure attracted 448% more flies than the leading traditional 30-watt unit.

FEATURES

- Innovative, patented* open top design gives maximum possible UV light output for increased efficacy
- Unique 'Z Shaped' killing grid gives 20% larger useful killing area for increased efficacy
- Large capacity, mains interlocked catch tray with anti-blow out folds
- Unique dual wavelength Synergetic® technology for an increased catch
- Tool free, swing down front guard for quick, simple servicing
- Simple wall, ceiling or desk mounting
- Contemporary market leading design
- Application: Commercial backroom

SPECIFICATIONS

DIMENSIONS	—————	H 11.75 in / W 4.75 in / L 23 in
COVERAGE	—————	1300 sq ft
BULBS	—————	2 x TGX15-18
WEIGHT	—————	11 lbs



ALLURE

ITEM #	DESCRIPTION	MODEL #	ORDER #
1	Allure, 30 watts, stainless	-	ZC030

ELECTRIC GRID FLY LIGHTS

EXOCUTOR

The Exocutor brand has been a favorite with specifiers for over 20 years, selected for its longstanding reliability and proven efficacy in demanding commercial environments. The contemporary design ensures that they are easily identified as high quality Synergetic branded products, while the carefully crafted, innovative product features deliver superior efficacy against traditional fly lights.

The Exocutor range is full of features designed to maximize useful UV light output, from the internal aluminum UV light reflectors, designed to re-use the powerful insect attracting wavelength of the Philips BL 368nm bulbs, to the unique light scoops which allow light to exude from the corners of the unit as well as the front, back and sides. Staggered bulb positioning ensures that the maximum amount of UV light is radiated from all areas of the unit, luring flying insects into the highly effective triangular killing grid.

FEATURES

- Unique corner light scoops give increased UV light output
- Internal aluminium UV light reflectors
- Staggered, high efficacy UV bulbs for maximum light output
- Reliable high specification 3750v transformer
- Unique triangular killing grid for a larger effective catch area
- Strong UV stable polycarbonate and coated mild steel /stainless steel construction
- Large capacity, mains interlocked catch tray with anti-blow out folds
- Simple wall, ceiling or desk mounting
- Easy cleaning and servicing
- Application: Commercial + industrial backroom

SPECIFICATIONS

DIMENSIONS	H 10.5 in / W 5.5 in / L 27.25 in
COVERAGE	3014 sq ft
BULBS	2 x TPX36-24S
WEIGHT	12.5 lbs



EXOCUTOR

ITEM #	DESCRIPTION	MODEL #	ORDER #
1	Exocutor, 80 watts, stainless	-	EX80S/110

FAQs

POSITIONING A FLYLIGHT

Every application is unique, so each situation requires an individual assessment for fly light positioning, however, there are basic principles that should be followed:

- Recommend enough units to cover the area to be protected
- Install units away from sources of light competition, such as windows, doors and high powered artificial light sources
- Consider sources of heat and airflow, such as heaters / AC units
- Don't install electric grid units directly above sensitive areas, such as food preparation areas
- Glue board units should be used in sensitive applications such as food preparation or production areas
- Consider access for installation and future servicing
- Wherever possible, fly lights should be positioned at 90° to sources of natural light, such as windows, doors and skylights
- Fly Lights should be positioned in between potential entry points, so as to intercept flying insects before they reach sensitive areas
- Fly lights should not be installed either too high or too low in the area to be protected, with an optimum height of around 6 feet and 7 inches

FLYMAP

INSECT CONTROL

- Electric Grid - Backroom
- Glueboard - Sensitive area
- Decorative - Front of house

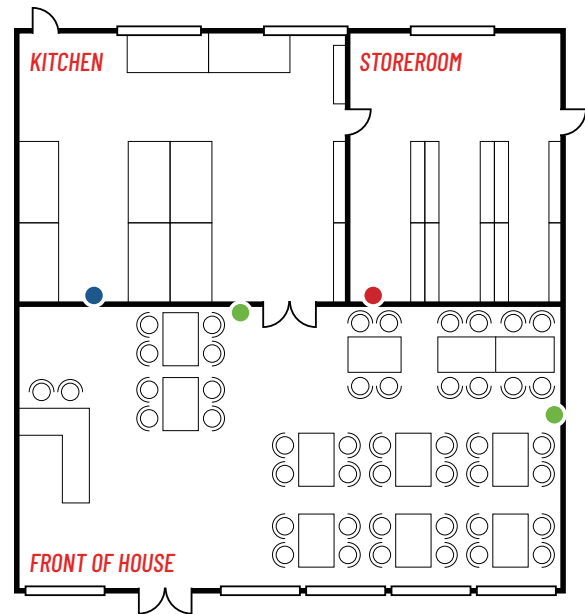

HOW OFTEN SHOULD BULBS BE CHANGED AND WHY?

We recommend that UV bulbs are changed every 12 months to ensure maximum efficacy. The levels of UV produced by fluorescent bulbs deteriorates rapidly throughout the life of the bulb. While the bulb will continue to glow blue or green indefinitely, after approximately 8,000 hours the amount of useful UV (which humans cannot see) drops to a level where it is no longer attractive to flying insects. As a result, UV bulbs must be replaced annually to ensure they remain effective in producing useful levels of UV. This replacement cycle is typically undertaken just before the peak insect season, (March/ April in North America) to ensure the flylight is producing the maximum amount of UV throughout the critical insect season.

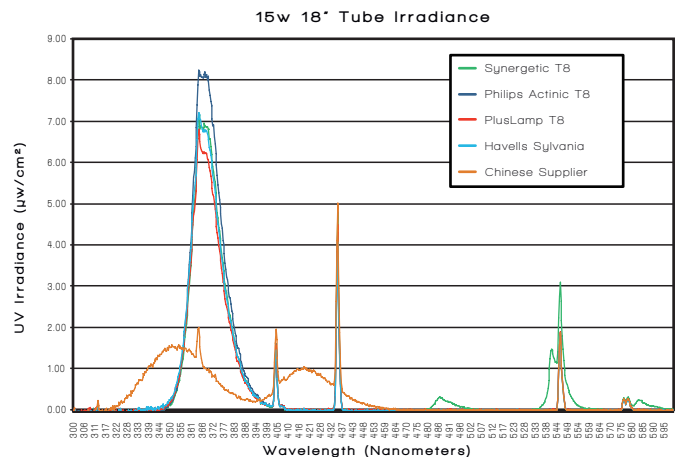

BULBS

SYNERGETIC

Easily recognized by their glowing green light, Synergetic® bulbs have been developed to attract a much wider range of flying insects than traditional blue UV bulbs. Based upon a unique phosphor mix, advanced technology ensures that a broader 'two peak' wavelength is maintained (368nm and 540nm) attracting a wide range of insects including stored product moths, while attracting the common housefly as effectively as traditional blue UV bulbs, giving you the best of both UV technologies. Extensive testing has been carried out over many years by independent entomologists and test laboratories, showing the benefits of green light in combination with UV.

A wide diversity of insects were shown to be more attracted to Synergetic® light, including greenhouse whiteflies, silver leaf white flies, thrips, leaphoppers, Indian meal moths, Mediterranean flour moths³, tropical warehouse moths, warehouse moths⁴, plus many more!

PHILIPS

Philips Lighting is a leading provider of lighting solutions for professional applications. The range of Philips UV bulbs is dedicated to providing innovative, energy-efficient solutions and applications for lighting, based on a thorough understanding of customer needs. Philips bulbs are available in a range of sizes and shatterproof options.

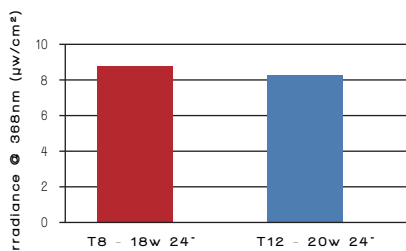
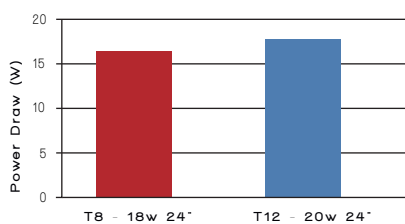

Philips bulbs are available in a comprehensive range of models, including shatterproof versions. The range also features the innovative new T8 18w and 36w tube, offering a contemporary low power, increased efficiency replacement for 20w and 40w T12 bulbs.

DID YOU KNOW?

Many insect pests of public health, stored product and agricultural importance have evolved visual pigments which allow them to perceive green light. 5 Recordings of electroretinograms in housefly eyes found peaks in both UV (340-365nm) and blue green (450- 550nm) 6 with similar sensitivities found in other Diptera eg. Calliphora vicina Meig⁷, Haematobia irritans L., Musca autumnalis De Geer, Stomoxys calcitrans L.⁸, Glossina mortisans mortisans Westw.⁹, and Fannia canicularis L.¹⁰, as well as the mosquito Aedes aegypti (323-345nm and 523nm) ¹¹. Several Tabanid species were also found to have a peak activity of 400-600nm¹².

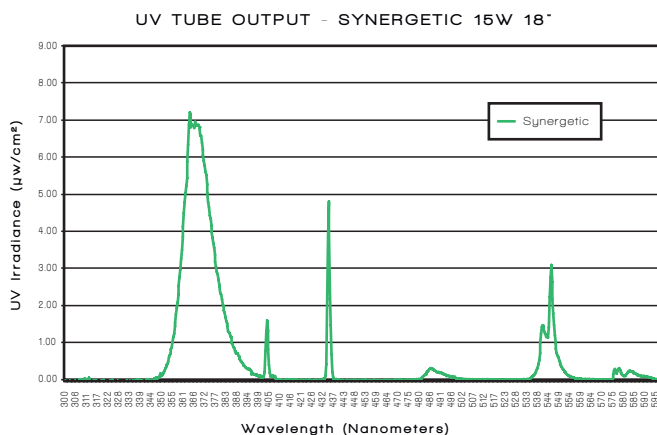

DID YOU KNOW?

Some stored-product beetles respond better to blue UV light, including the cigarette beetle, the merchant grain beetle, the rice weevil and the red flour beetle.

BULBS

PLUS + LAMP

Offering superb value, the PlusLamp™ range offers users a wide choice of 368nm blue UV bulbs in both standard or shatterproof options. Testing showed that the PlusLamp™ 368nm range experienced a lower rate of deterioration than many leading brand UV bulbs.

SHATTERPROOFING

Shatterproof bulbs provide peace of mind in sensitive areas by retaining glass shards if the bulb is broken. All our ranges can be shatterproofed, ensuring that you can choose your ideal bulb to help you protect even the most sensitive areas, including food preparation and assembly areas. Shatterproof bulbs MUST be installed in areas operating a 'glass free policy'. The Fluorinated Polymer (FEP) material used for all our sleeving is designed specifically for optical transmission and allows 97% of effective UV light to pass through the coating. As a result, the maximum possible amount of useful UV irradiance passes through the sleeving to effectively attract insects. With only 3% of the irradiance being absorbed into the material, the structural integrity of the sleeving is maintained for the full 12 month life of the bulb, preventing discoloring and ensuring all glass shards are retained in the event of a breakage.



LED TECHNOLOGY

LED (Light Emitting Diode) technology has become more viable in recent years due to the increase in demand across a wide range of industries and applications. Due to the many benefits of LED technology, investment in the research and development of this technology has been made over many years, to ensure its suitability for use in the flying insect control industry.

Pelsis LED technology offers a wide range of benefits to UV flylights. One of the main benefits of LED technology is that they do not contain any toxic elements. In addition to this, their low energy consumption and high UV light output efficiency make them both more environmentally friendly and cost effective to power, in comparison to UV flylights that use traditional fluorescent bulb technology. The compact size of the Pelsis LED strip compared to fluorescent glass bulbs allows for storage and transport cost savings for our customers.

Another benefit to LED technology is that it's not only more durable compared to current UV fluorescent bulbs. There is also a lower risk of premature lighting failure, which can be caused by shocks and vibrations, a fault more commonly seen in fluorescent bulbs. Pelsis LED technology, when paired with effective heat management features like those found within Synergetic LED fly lights, ensures a long working life for LEDs which helps to reduce ongoing service costs.

JUST SOME OF THE BENEFITS OF PELSIS LED TECHNOLOGY

- 3 year effective life - reduced maintenance costs
- Energy efficient - offers lower running costs and reduced electricity consumption
- Environmentally friendly - houses and produces zero toxic elements
- Durability - more resistant to damage from vibration and shock
- Compact - reduced unit and storage space



GLUEBOARDS

GLUPAC

Glupac® glueboards are designed to perfectly complement your Synergetic® fly light, offering consistently high standards of performance and quick servicing times.

EASY FLY COUNT GRIDS

Glupac® glueboards feature simple grids to make it quick and easy to monitor and record fly counts and identify species. This allows valuable, accurate feedback to be kept for hygiene audits and shared with the end user on a regular basis.

SILICON COATED RELEASE PAPER

Glupac® release paper is silicon coated to ensure that it releases from the glue covered board quickly and simply, leaving the glue in place. This guarantees speedy service times and ensures that there is no contact between the glue and the service technician.

FEATURES

- Unique flexible glue application allows for maximum glue area
- Advanced UV stable glue guards against the glue drying out over a four week period
- Dry glue formulation reduces glue run from exposure to bulb heat and mess free servicing
- Consistent thickness of glue application ensures no areas are too thin to retain the caught insect
- Varnished base material reduces absorption of the glue
- High quality silicone coated release paper provides easy peel action, less mess and reduced service times

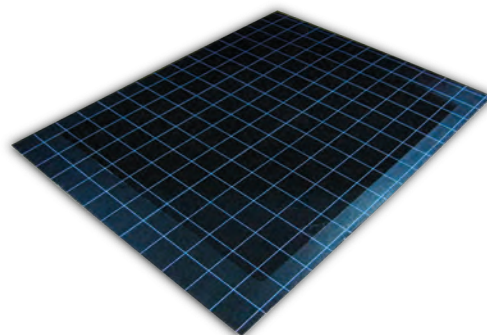
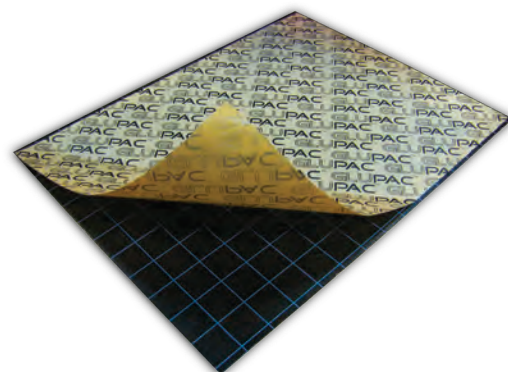
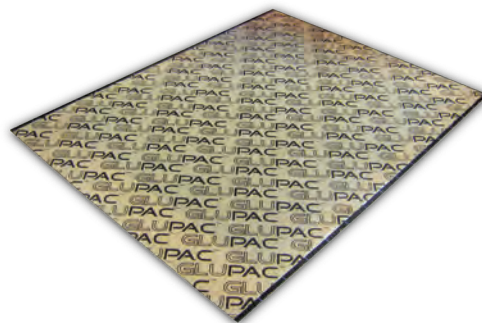

PRODUCT SELECTOR

COMMERCIAL - FLYLIGHT PRODUCT

Use our simple guide to help you select the perfect flylight for your type and size of application.

COMMERCIAL

APPLICATION COVERAGE (ft ²)	FRONT-OF-HOUSE			KITCHEN			BACKROOM			SPECIALIST
	0-450	451-1075	1076-1615	0-540	541-1075	1076-1615	0-540	541-1075	1076-1615	0-540
GLUEBOARD FLYLIGHTS										
Edge	●	●	●	●	●	●				
Halo (2nd Gen)	●	●	●	●	●	●				
Flytrap Professional			●	●	●					
SPECIALIST FLYLIGHTS										
EX Elite										
Halo Aqua	●	●	●	●	●	●				●
KILLING GRID FLYLIGHTS										
PlusZap				●	●		●	●		
Exocutor							●	●	●	
Allure				●	●	●	●	●	●	
DECORATIVE FLYLIGHTS										
Nectar	●									●
Aura/Aura Black	●									
Halo Curve	●	●								
Luralite Cento Plus	●									
Luralite Professional	●	●								
Flypod	●									

PRODUCT SELECTOR

INDUSTRIAL - FLYLIGHT PRODUCT

For further help and advice please call toll free (877) 928-2847 or email customer care.na@pelsis.com

INDUSTRIAL

APPLICATION COVERAGE (ft ²)	FOOD PREPARATION				BACKROOM				SPECIALIST			
	0-540	541-1075	1076-1615	1615+	0-540	541-1075	1076-1615	1615+	0-540	541-1075	1076-1615	1615+
GLUEBOARD FLYLIGHTS												
Edge	●	●	●									
Halo (2nd Generation)	●	●	●	●								
Flytrap Professional	●	●	●	●								
SPECIALIST FLYLIGHTS												
EX Elite									●	●	●	●
Halo Aqua	●	●	●						●	●	●	
KILLING GRID FLYLIGHTS												
PlusZap												
Allure												
DECORATIVE FLYLIGHTS												
Nectar												
Aura/Aura Black												
Halo Curve												
Luralite Cento Plus												
Luralite Professional												
Flypod												

PRODUCT SELECTOR

BULB & UV LED STRIP - FLYLIGHT PRODUCT

Use this quick and easy reference guide to find the right bulbs for your flylight. To find out more about each of our bulb brands, please turn to pages 75 and 76 or alternatively call our team on (877) 928-2847 who would be happy to advise you on bulb selection.

PART NO.	DESCRIPTION	BULBS			
		QUANTITY	BRAND	PART NO.	
ZC008/110v	IF100 S/S	4	PlusLamp™	TVX25-TB	25w, 9.5"
ZC010/110v	Allure 30	2	Synergetic®	TGX15-18	15w, 18"
ZF028/110v	FTP30	2	Philips	TPX15-18S	15w, 18"
ZF033/110v	FTP80	2	Philips	TPX36-24S	36w, 24"
ZF050/110v	Flypod	1	Philips	TPX18	18w, 9"
ZF100/110v	Halo 30 (1st Generation)	2	Philips	TPX15-18	15w, 18"
ZF101/110v	Halo 45 (1st Generation)	3	Philips	TPX15-18	15w, 18"
PZ30W/110V	PlusZap 30 White	2	PlusLamp™	TVX15-18	15w, 18"
HL15/110v	Halo 15 (2nd Generation)	1	Synergetic®	TGX15-18	15w, 18"
HL30/110v	Halo 30 (2nd Generation)	2	Synergetic®	TGX15-18	15w, 18"
HL45/110v	Halo 45 (2nd Generation)	3	Synergetic®	TGX15-18	15w, 18"
HL45IP/110v	Halo 45 Aqua	3	Synergetic®	TGX15-18S	15w, 18"
HLCURVE/110V	Halo Curve	2	Synergetic®	TGX15-18	15w, 18"
INFINITI	INFINITI	2	Pelsis LED	LED8S	N/A
ZF105/110v	Edge 30	2	Synergetic®	TGX15-18	15w, 18"
ZL009/110v	Luralite Cento Plus	1	Philips	TPX18	18w, 9"
ZL015/110v	Luralite Professional	2	Philips	TPX15-18	15w, 18"
ZL022/110v	Satalite 30	2	Philips	TPX15-18	15w, 18"
ZL051/ZL051-BLACK/110v	Aura/Aura Black	1	Synergetic®	TGX22	22w
ZL055/110v	Nectar	1	Synergetic®	TGX15-18S	15w, 18"
EX80S/110v	Exocutor 80	2	Philips	TPX36-24S	36w, 24"
ZSP005/110v*	Excalibur Aqua 80	2	Philips	TP40-24S	36w, 24"
EX ELITE	EX Elite	2	Synergetic	TGX18-24S	18w, 24"













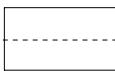

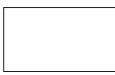
*Adaptor required for models up to 2015

All bulbs are also available in shatterproof versions – please specify if shatterproof is required when ordering by inserting the letter 'S' after the product code.

PRODUCT SELECTOR

GLUEBOARD - FLYLIGHT PRODUCT

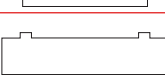
Use the reference guide below to quickly select the recommended glueboards for your flylight. Simply locate your flylight product code and find the corresponding glueboard pack code to make ordering simple. To find out more about Glupac® glueboards please visit page 77 or alternatively call our team on (877) 928-2847 who would be happy to advise you on glueboard selection.

FLYLIGHT MODEL NO.	DESCRIPTION	QTY.	PART NO.	SHAPE	GLUEBOARD			DIMENSIONS (INCH)
					COLOR	PACK SIZE	ALTERNATIVE / COLOR	
ZF028/110v	FTP30	1	GB001		Yellow	6	GB002/GB005 Black	15.6 x 12.2
ZF033/110v	FTP80	1	GB011		Yellow	6	GB012 Black	21.4 x 12.2
ZF050/110v	Flypod	1	INF252		White	6	-	6.7 x 9.4
HL15/110v	Halo 15 (2nd Generation)	1	GB015		Black	6	GB005 Black	21.3 X 12
HL30/110v	Halo 30 (2nd Generation)	1	GB012		Black	6	GB011 GB001 GB002/GB005 Black/Yellow	15.6 x 12.2
HL45/110v	Halo 45 (2nd Generation)	1	GB012		Black	6	GB011 GB001 GB002/GB005 Black/Yellow	15.6 x 12.2
HL45IP/110v	Halo 45 Aqua	1	GB013		Yellow	6	GB001/GB002 Yellow	21.3 X 12
HLCURVE/110V	Halo Curve	1	GB005		Black	6	-	15.6 x 12.2
INFINITI	INFINITI	1	INL288		Black	6	-	15.6 x 12.2
ZF105/110v	Edge 30	1	INF198		Black	6	-	17.7 x 15
ZL009/110v	Luralite Cento Plus	1	INL128		Black	6	-	-
ZL015/110v	Luralite Professional	1	INL121		Yellow	6	INL132 Black	22.4 x 10.8
ZL022/110v	Satalite 30	1	INL161		White	6	-	19.1 x 8.1
ZL051/ZL051-BLACK/110v	Aura/Aura Black	1	INL198		Yellow	6	-	11.6 Dia
ZL020	Satalite 18 Aluminium	1	INL147		White	6	-	9.6 x 5.3
ZL055/110v	Nectar	2	INL170		Yellow	12	-	4.5 x 17.7
EX21	EX Elite	2	6139		Black	6	-	25.4 x 11.8

RODENT CONTROL

OUTSMART RODENTS WITH DISCRETION AND SIMPLICITY.

B&G rodent control stations do all the work for you. Use non-fatal bait to monitor activity or a combination of bait and snap-trap for final control.



RODENT CONTROL

FAST-CATCH RODENT CONTROL DOWN TO A "T."

The Fast Catch can be used for monitoring with non-toxic bait and then when activity is present a snap trap can be used for final control. It can also be utilized as a "stand alone" snap trap or rodent bait station.

The Fast Catch station is available in two models: Station-only design, and a Rodent Alert design. The Rodent Alert stations feature a 'pop-up alert' that indicates when the snap trap inside the station has been triggered.

FEATURES

- Heavy duty construction
- Easy open single lock design
- Reusable - designed for years of service
- Tamper resistant - lid recesses into base
- Low profile design for increased rodent activity
- Fits all professional rat snap traps and includes bait rods
- Pop-outs in rear of station allows for attachment

PLACES TO USE

- Sensitive Accounts - where rodenticide is banned
- Residential Accounts - keeps rats hidden from occupants
- Commercial kitchens, restaurants and office complexes



RODENT CONTROL

RODENT STATION ATTACHMENT SYSTEM

FEATURES

- The station attachment system consists of 2 clamps, a metal screw and washer. It is designed for use with a 12 inch x 12 inch (1.5 inch thick) concrete paver, and only with B&G rodent stations
- Easy and economical way to secure the Fast Catch and rodent bait station
- Holds station securely to block and is reusable pop up alert

SPECIFICATIONS

- Attaches any B&G rodent station to a 12 inch x 12 inch paver block
- Installs in less than 30 seconds
- Heavy duty metal construction

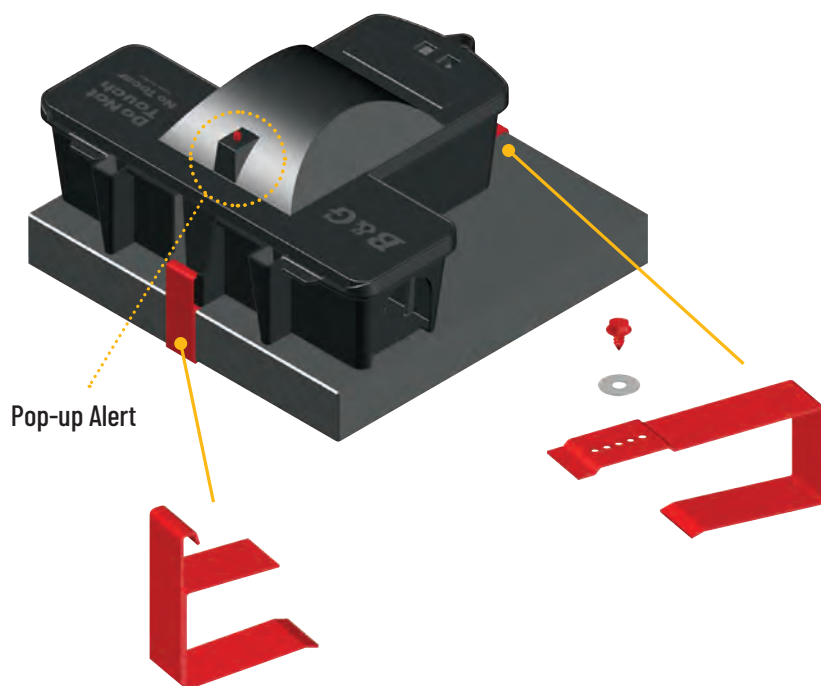

ITEM #	DESCRIPTION	MODEL #	ORDER #
1	Fast Catch Station with Rodent Alert	-	25000309
2	Fast Catch Station	-	25000308
3	Fast Catch 6 Pack with Attachment System	-	35000308
4	Fast Catch Alert 6 Pack with Attachment System	-	35000309

RODENT CONTROL PARTS

ITEM #	DESCRIPTION	MODEL #	ORDER #
1	Extra Key Pack - 15 Keys	-	25000205
2	Attachment System Kit	-	5000260-C

TECHNICIAN'S SERVICE CASES

PORTABLE CASES DESIGNED TO FIT INTO ANY SERVICE VEHICLE.

FEATURES

- Rotationally molded heavy-duty construction
- Molded in pockets to hold aerosols, dust bulbs, and AccuSpray products
- Open area for bait guns, monitors, flashlights or other tools
- Available as a plain case with no interior pockets
- Literature holder in rear of case
- Ergonomic design
- Compact—measures 13 inch x 13 inch x 14 inch high
- Variety of colors available
- Additional colors available: blue, red, black and green



Private label here

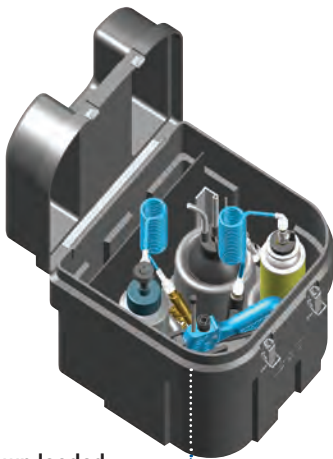

Case shown loaded with separately sold products

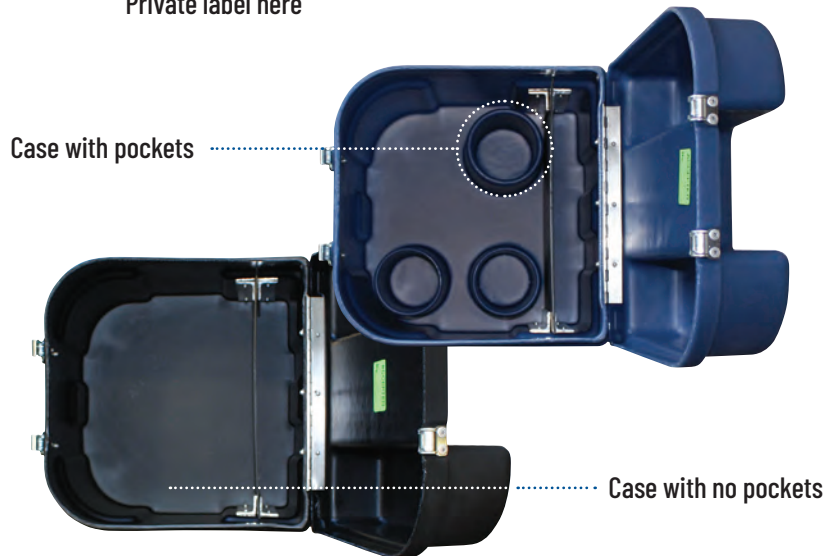

Case with pockets

Case with no pockets

ITEM #	DESCRIPTION	MODEL #	ORDER #
1	Gray - With Pockets	-	11008050
2	Black - With Pockets	-	11008051
3	Blue - With Pockets	-	11008052
4	Green - With Pockets	-	11008053
5	Red - With Pockets	-	11008054
6	Gray - No Pockets	-	11008055
7	Black - No Pockets	-	11008056
8	Blue - No Pockets	-	11008057
9	Green - No Pockets	-	11008058
10	Red - No Pockets	-	11008059

TECHNICIAN'S SERVICE CASES

B&G CARRY CASES

B&G CARRYING CASES ARE ROTATIONALLY MOLDED FOR YEARS OF DURABILITY.

FEATURES

- Seamless construction, no leaks
- Child-resistant lock
- Jumbo Case holds B&G Tank Sprayers and other equipment
- Contact B&G for color and sizes available

WHEELED JUMBO CASE

FEATURES

- Heavy duty aluminum frame
- Removable stainless handle
- Durable wheels

1 JUMBO CASE



2 JUNIOR CASE



3 WHEELED JUMBO CASE



ITEM #	DESCRIPTION	MODEL #	ORDER #
1	Compact Case with child-resistant lock - 16.5" x 9.75" x 16.5"	763 Grey	11008075
2	Jumbo case with child-resistant lock 16.75" x 14" x 19.25"	760 Grey	16016100
3	Jumbo Wheeled Carry Case	-	12011035

SERVICE CASES

B&G IPM KIT WITH ACCUSPRAY ELITE

The new IPM Case instantly lets your customer know that you are a professional. Use it to organize all your application tools.

FEATURES

- Outer zipper pocket holds frequently used items like insect monitors and bait stations
- Inner zipper compartment organizes bait tubes and bait gun
- Pockets on each side can hold Aerosols or AccuSpray units
- Inside the case can be customized using the adjustable dividers
- D-rings keep B&G Bulb Duster and accessories within reach
- Rear Velcro flap pocket



SERVICE CASES

CASE ONLY

Use your own IPM tools.



B&G IPM KITS

FEATURES

- Kit includes ADU, AccuSpray, Bulb Duster and Low Profile Monitors
- Bait Gun not included (shown for display purposes)



ITEM #	DESCRIPTION	MODEL #	ORDER #
1	IPM Kit with AccuSpray Elite	-	45000132
2	Case Only (No IPM Components)	-	45000165
3	IPM Kit with BASF ADU	-	45000151

Contact us to learn more:

800-544-8811

us.pelsis.com

135 Region South Drive,
Jackson, GA 30233

WE ARE  **pelsis**

A FAMILY OF BRANDS WITH ONE SHARED PURPOSE

B&G

CURTIS DYNA-FOG[®] _{Ltd.}

SYNERGETIC[®]

 **EDIALUX**
PROFESSIONAL PRODUCTS

NETWORK

P+L Systems[®]
Washroom

SILVANDERSSON 

AGRISENSE